

INDUSTRIAL

OEM

RETAIL

DETAILING



PRODUCT CATALOG





TO OUR CUSTOMERS

Whether you're a friend who gave advice along the way, someone who helped introduce our products to the world, a professional in the field or an avid hobbyist,

THANK YOU

You are part of our success at Lake Country Manufacturing and the momentum to keep developing the best buffing and polishing products that can be built.

We appreciate your feedback and support in our industry.

- Schneider Family

COVER IMAGE PROVIDED BY:
CONNOR HARRISON DETAILING OF CHDETAIL

TABLE OF CONTENTS

About Us	02	LC Originals.....	06 – 12	Knitted Pads	32 – 39	Master Aggression Chart.....	48
Markets Served	03	Rotary (CCS Technology™ & Flat Foam)		Prewashed Knitted Lambswool, Purple Foamed		Backing Plates	49 – 50
Tool Guide.....	04	DA (CCS Technology™ & Flat Foam)		Wool, Blue Hybrid Wool, Knitted 100% Wool,		Accessories	51 – 52
Foam Pads	05	LC Specialty Lines	13 – 30	Knitted Wool/Acrylic		Applicators, Microfiber Towels,	
		HDO, SDO, Force Foam, Waffle Pro Foam,		Tufted Pads	40 – 47	Pad Washers, Rotary Extensions,	
		Hydro-Tech, Microfiber, Better Edge,		Steamed, Unsteamed		Scuff Balls, Wool Balls	
		Tufted Foam, Mini Pads				Care Instructions	53 – 54



AN INDUSTRY LEADER

With 49 patents worldwide, Lake Country has been an industry leader in the development of innovative polishing products, pads, and accessories. For decades, Lake Country has continued to raise the bar, and evolve to fit the needs of our constantly growing and changing market.

DECADES OF EXPERTISE

We have over 60 years of in-the-trenches, hands-on experience covering all aspects of body work, painting and buffing in the automotive, marine and aerospace industries. Lake Country's facility and testing operations are set-up to fully utilize measuring equipment and perform quantitative product evaluations to develop innovative products for the buffing and polishing industry across the world.

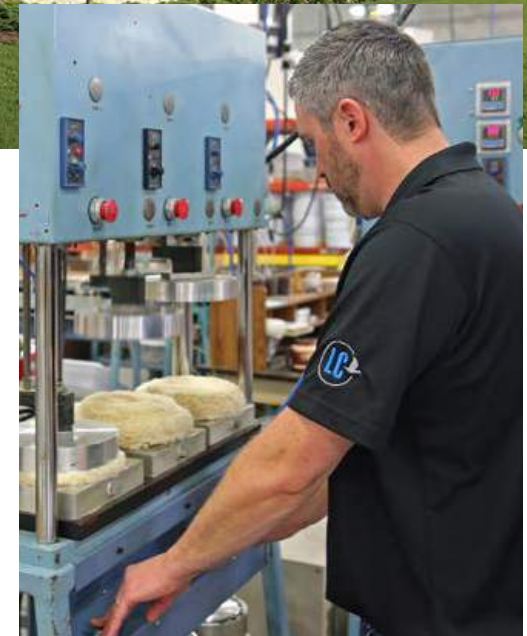

DESIGNED FOR EVERY UNIQUE MARKET

In every listed
category we serve:

PBE, automotive,
marine, aviation and
composite industries.

With more than 60 years of hands-on, in-the-trenches detailing and product development experience, Lake Country knows what it takes to make your customers happy. Our team is dedicated to delivering profitable solutions for our customers with a mix of premium buffing and polishing pads and accessories.

DETAILING



The wide variety of product choices available to your buyers can be overwhelming. Lake Country will work with you to be sure you have the best mix of premium products to satisfy both professionals and DIY/hobbyists. We also know the importance of competitive pricing, fast delivery, and ongoing new product development to meet customer demands.

INDUSTRIAL



Industrial suppliers are tasked with providing quick turnaround to professional buyers who rely on that speed to get their job done. Lake Country works to ensure that you'll have the premium products to meet your customer's needs. With hundreds of variations, Lake Country offers a wide variety of products for multiple applications.

OEM

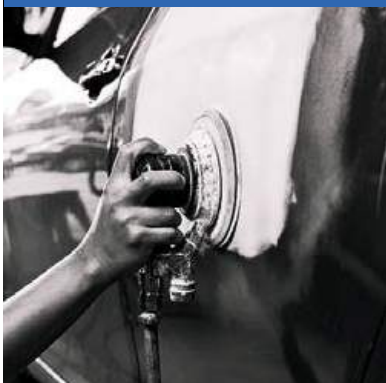

We understand the daily pressures placed on our OEM customers to meet production schedules. Lake Country pads provide consistent performance and programs designed to keep production lines running. Our experienced team will work with you to develop innovative products designed to work in lock step with your products.

RETAIL/PRIVATE LABEL



We work closely with our retail partners to provide the best mix of high quality buffing and polishing products that deliver a high turn ratio. A commitment to quick fulfillment and quality is well-suited to the fast-paced retail market. Our expert team and online product advisor tool are available to support in-store staff or customers with technical questions.

RECOMMENDED TOOLS

TOOL GUIDE

Every technician or professional has a tool that helps them get the job done. Our trade is no different. We developed our products with professional and consumer grade products in mind and recommend the right tool for our pad lines.

1 DA (DUAL ACTION)



2 ROTARY

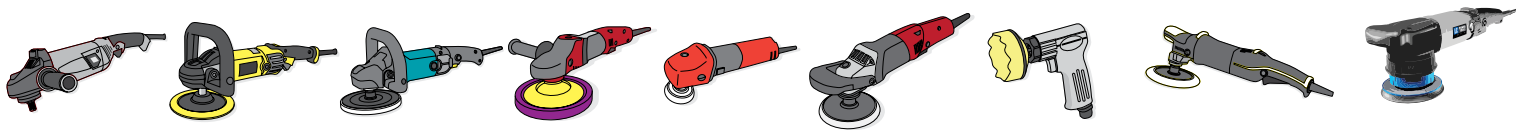

3 FORCED ROTATION DA

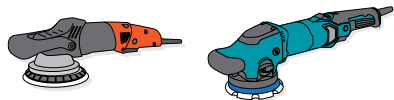

4 LONG THROW DA (15mm — 21mm)

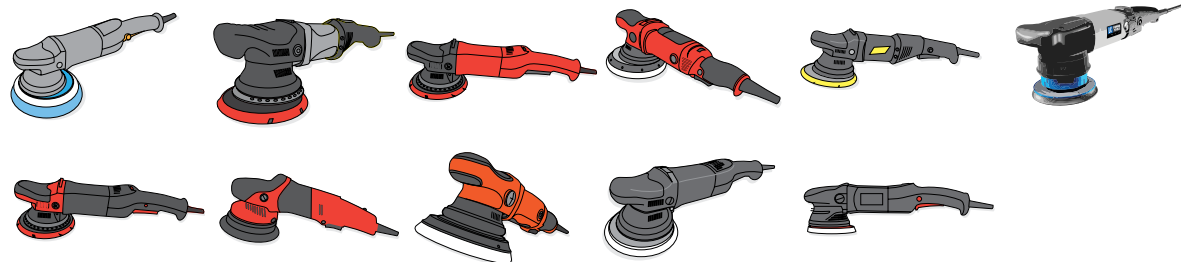

5 MINI LONG THROW

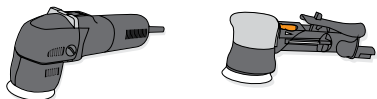

6 MICRO POLISHER

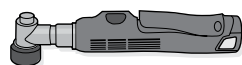

NOT ALL PADS ARE CREATED EQUAL

FOAM PADS

SCIENCE OF FOAM

Lake Country's premium engineered foams are developed and sourced worldwide to offer the best products available. Hundreds of hours go into testing, research and development dialing in the specific foam formulations we use to get the perfect results and making your life easier. Foam is typically broken down into two categories being reticulated and non-reticulated.



Open cell foam
75x magnified

RETICULATED FOAM (OPEN CELL)

In reticulated or open cell foam there are a few, if any, intact bubbles or cell windows, similar to a net. Think of a window frame without glass.

- Resistance to compression is decreased (same foam will feel less firm if reticulated).
- Tear resistance is increased making pads more durable, reducing heat and increased performance on long throw DA polishers
- Chemicals are absorbed faster than non-reticulated resulting in more waste but are more durable and typically increase longevity of the cutting power during the polishing cycle.

Primary Choice

Open cell foam is the majority of Lake Country's product.

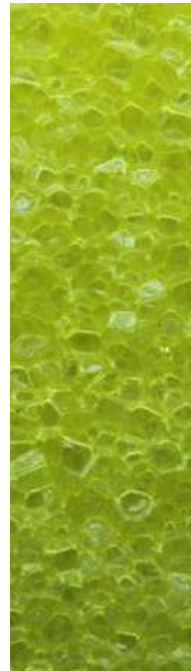

Closed cell foam
75x magnified

NON-RETICULATED FOAM (CLOSED CELL)

Non-reticulated foam pores are completely sealed with windows intact or film covering the cell. Due to the density and construction, polish becomes more difficult to absorb, keeping the polish or abrasive on the surface to increase working time and efficiency of the polishing cycle.

- Closed cell pads reduce absorption of polish and keep abrasive on the pad surface to increase performance and save on polish usage.
- Reduced durability of overall foam product leads to a shorter lifespan in comparison to open cell variations.

CLASSIC EVOLUTION

REFINED

**CCS & FLAT FOAMS
IN ONE COHESIVE LINE
LC ORIGINALS**

SIMPLE 6 PAD SYSTEM

Our most united pad system available. LC Originals offers pads with a wide range from heavy cutting to final finishing.

EXACT FIT BACKING

Every LC Original pad features an exact fit loop for perfect alignment to the backing plate.

CCS TECHNOLOGY™

Independent columns evenly disperse polish from the CCS pockets onto the working surface.

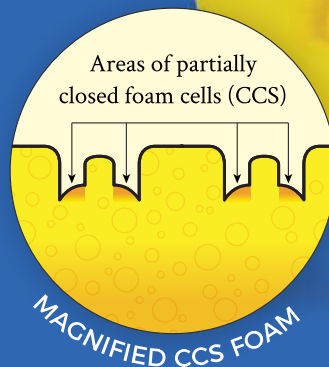

CCSTECHNOLOGY™

FLAT FOAM



SLOW ABSORPTION RATE

CCS pockets enhance performance by reducing polish absorption.



PREVENTS PAD SKIPPING

CCS pockets reduce surface friction allowing operator to run pad flat on a working surface.



CREATES LESS HEAT

CCS pockets reduce surface contact resulting in less friction generated heat.

LAKE COUNTRY

ORIGINALS

CCS TECHNOLOGY™ & FLAT FOAM

BACKGROUND

Conventional foam pads absorb polish too quickly. This reduces polish and pad performance because most of the polish is trapped below the working surface of the pad. CCS Technology™ solves this common problem using strategic patterns of partially closed foam cells.

ROTARY AGGRESSION CHART

This chart is applicable for LC Original Rotary pads.

RECOMMENDED TOOLS: ROTARY **2**

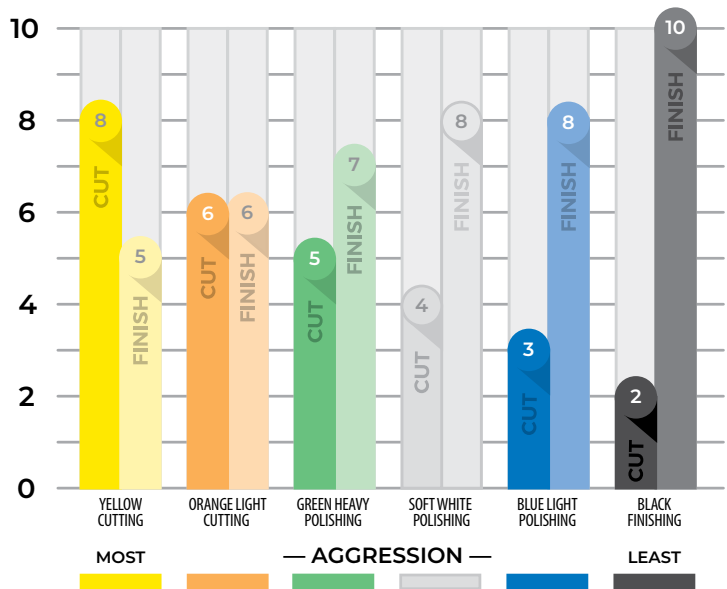

DUAL ACTION AGGRESSION CHART

This chart is applicable for LC Original Dual Action pads.

RECOMMENDED TOOLS: DA **1**

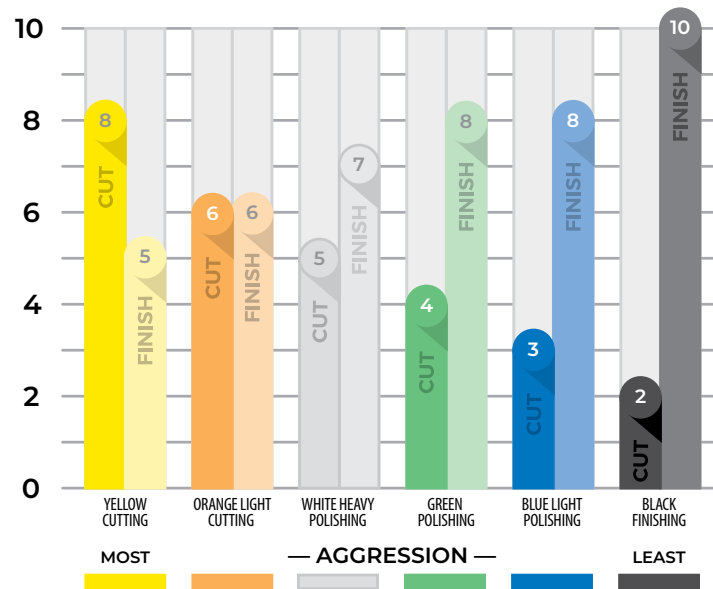

PRECISION ROTARY

LC ORIGINALS

RECOMMENDED TOOLS: ROTARY 2

The precision rotary line offers the LC original foams in an updated shape or profile to maximize performance, durability, flexibility and accuracy when polishing.

Precision Rotary		Description	Thickness	8"	8"	7"	7"	6"	6"	4"	4"
CCS Technology	Flat Foam			CCS Technology	Flat Foam	CCS Technology	Flat Foam	CCS Technology	Flat Foam	CCS Technology	Flat Foam
				Fits 7" Backing Plate		Fits 6" backing plate		Fits 5" backing plate		Fits 3" backing plate	
		Yellow Foam Cutting Pad	1-1/4"	PR-54800-CCS	PR-54800	PR-54700-CCS	PR-54700	PR-54600-CCS	PR-54600	PR-54400-CCS	PR-54400
		Orange Foam Light Cutting Pad		PR-24800-CCS	PR-24800	PR-24700-CCS	PR-24700	PR-24600-CCS	PR-24600	PR-24400-CCS	PR-24400
		Green Foam Heavy Polishing Pad		PR-34800-CCS	PR-34800	PR-34700-CCS	PR-34700	PR-34600-CCS	PR-34600	PR-34400-CCS	PR-34400
		Soft White Foam Polishing Pad		PR-64800-CCS	PR-64800	PR-64700-CCS	PR-64700	PR-64600-CCS	PR-64600	PR-64400-CCS	PR-64400
		Blue Foam Light Polishing Pad		PR-94800-CCS	PR-94800	PR-94700-CCS	PR-94700	PR-94600-CCS	PR-94600	PR-94400-CCS	PR-94400
		Black Foam Finishing Pad		PR-74800-CCS	PR-74800	PR-74700-CCS	PR-74700	PR-74600-CCS	PR-74600	PR-74400-CCS	PR-74400

PROFILE

Attachment method:

Hook & loop

Backing plate 43-175M

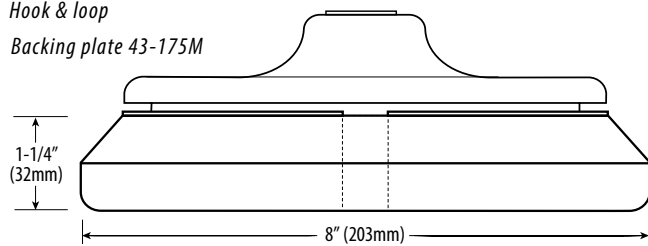

Backing plate:

45-936

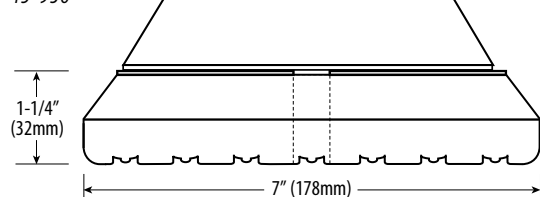









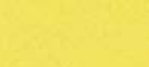

CURVED EDGE ROTARY

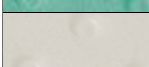
LC ORIGINALS

RECOMMENDED TOOLS: ROTARY 2

CCS & Flat Foam pads made exclusively for use on rotary machines.
The curved edge helps center the pad on the backing plate.

Curved Edge		Description	Thickness	7-1/2"	7-1/2"	6-1/2"	6-1/2"	5-1/2"
CCS Technology	Flat Foam			CCS Technology	Flat Foam	CCS Technology	Flat Foam	CCS Technology
				Fits 7" or 6-1/4" Backing Plate		Fits 6" Backing Plate		Fits 5" Backing Plate
		Yellow Foam Cutting Pad	7/8"					78-52550C
			1-1/4"	78-54750C	46-585	78-54650C	46-576	
		Orange Foam Light Cutting Pad	7/8"					78-22550C
			1-1/4"	78-24750C	46-285	78-24650C	46-276	
		Green Foam Heavy Polishing Pad	7/8"					78-32550C SOFT
			1-1/4"	78-34750C SOFT	46-385	78-34650C SOFT	46-376	
		Soft White Foam Polishing Pad	7/8"					78-62550C
			1-1/4"	78-64750C	46-685	78-64650C	46-676	
		Blue Foam Light Polishing Pad	7/8"					78-92550C
			1-1/4"	78-94750C	46-985	78-94650C	46-976	
		Black Foam Finishing Pad	7/8"					78-72550C
			1-1/4"	78-74750C	46-785	78-74650C	46-776	

PROFILE

Attachment method:
Hook & loop

Backing plate 43-175M

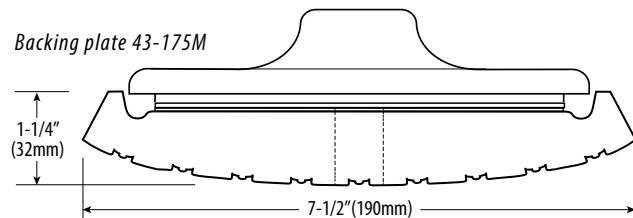

Backing plate 43-125WH

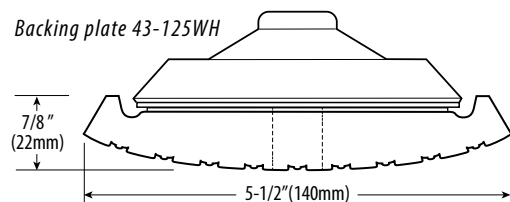











CUTBACK DA

LC ORIGINALS

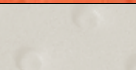
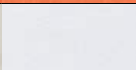
RECOMMENDED TOOLS: DA **1** FORCE ROTATION **3** MINI LONG THROW **5**

All pads have loop buffed back from edge to avoid hitting the buffing surface as well to help center on the backing plate.

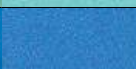
Note: *Mini Long Throw is only applicable to 3-1/2 pads. Long throw is only applicable to pads that are 7/8" thick.

Cutback		Description	Thickness	6-1/2"	6-1/2"	5-1/2"	5-1/2"	4"	3-1/2"	3-1/2"
CCS Technology	Flat Foam			CCS Technology	Flat Foam	CCS Technology	Flat Foam	Flat Foam Recommended Tool 1 Fits 3", 3-1/2", or 4" Backing Plate	CCS Technology	Flat Foam
				Fits 6" Backing Plate Recommended Tool 3 for all 6-1/2" pads that are 1-1/4" thick		Fits 5" Backing Plate Recommended Tool 3 for all 5-1/2" pads that are 1-1/4" thick		Fits 3" Backing Plate Recommended Tool 5		
		Yellow Foam Cutting Pad	7/8"	78-52650CCS-152	76-5265-152MM	78-52550CCS-130	76-5255-130MM	76-5240-89MM	78-52350CCS-76M	76-5235-76MM
			1-1/4"	78-5165-152M	76-5165-152MM	78-54550CCS-130	76-5455-130MM			
		Orange Foam Light Cutting Pad	7/8"	78-22650CCS-152	76-2265-152MM	78-22550CCS-130	76-2255-130MM	76-2240-89MM	78-22350CCS-76M	76-2235-76MM
			1-1/4"	78-2165CCS-152M	76-2165-152MM	78-24550CCS-130	76-2455-130MM			
		White Foam Heavy Polishing Pad	7/8"	78-62650CCS-152	76-6265-152MM	78-62550CCS-130	76-6255-130MM	76-6240-89MM	78-62350CCS-76M	76-6235-76MM
			1-1/4"	78-6165CCS-152M	76-6165-152MM	78-64550CCS-130	76-6455-130MM			
		Green Foam Polishing Pad	7/8"	78-32650CCS-152	76-3265-152MM	78-32550CCS-130	76-3255-130MM	76-3240-89MM	78-32350CCS-76M	76-3235-76MM
			1-1/4"	78-3165CCS-152M	76-3165-152MM	78-34550CCS-130	76-3455-130MM			
		Blue Foam Light Polishing Pad	7/8"	78-92650CCS-152	76-9265-152MM	78-92550CCS-130	76-9255-130MM	76-9240-89MM	78-92350CCS-76M	76-9235-76MM
			1-1/4"	78-9165CCS-152M	76-9165-152MM	78-94550CCS-130	76-9455-130MM			
		Black Foam Finishing Pad	7/8"	78-72650CCS-152	76-7265-152MM	78-72550CCS-130	76-7255-130MM	76-7240-89MM	78-72350CCS-76M	76-7235-76MM
			1-1/4"	78-7165CCS-152M	76-7165-152MM	78-74550CCS-130	76-7455-130MM			

PROFILE

Attachment method: Hook & loop

Backing plate 43-148DAR

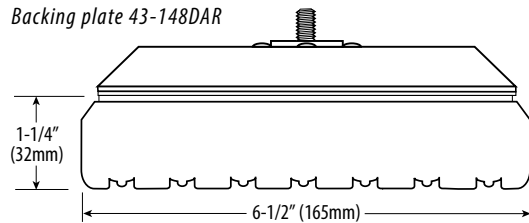

Backing plate 43-073DA

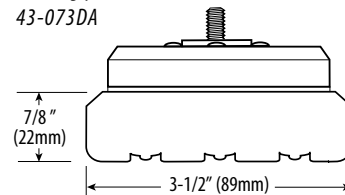

Backing plate 43-125DAR

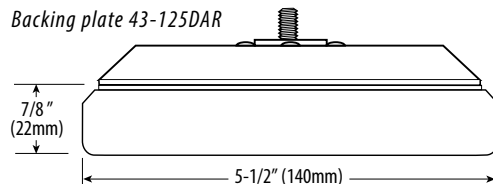



DOUBLE SIDED ROTARY

LC ORIGINALS

RECOMMENDED TOOLS: ROTARY 2

CCS Technology & Flat double sided pads have a highly engineered center plate designed to withstand the vigor's of heavy industrial use yet flexible to get into tight corners without breaking.

Double Sided		Description	Thickness	8"	8"	6"	6"
CCS Technology	Flat Foam			CCS Technology	Flat Foam	CCS Technology	Flat Foam
				Adapter 5/8"-11 Thread PN-46-229			
		Orange Foam Light Cutting Pad	1-5/8"	99-28800CCS	99-28800	99-28600CCS	99-28600
		White Foam Heavy Polishing Pad		99-68800CCS	99-68800	99-68600CCS	99-68600
		Black Foam Finishing Pad		99-78800CCS	99-78800	99-78600CCS	99-78600

PROFILE

Attachment method:
Bolt-on adapter 46-229 or
46-229-14MM

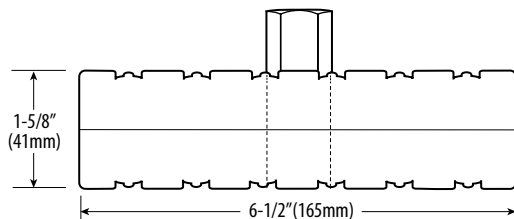
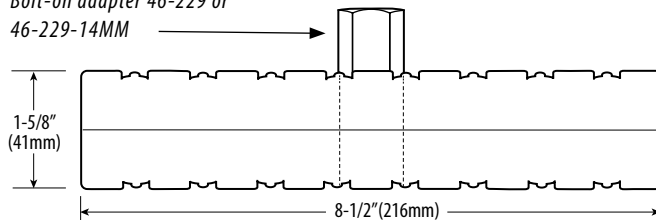

PHOTO/DETAILER:
CONNOR HARRISON DETAILING OF CHDETAIL

**BUILT
FOR THE
RELENTLESS**



TAPERED EDGE
Prevents pad rolling & provides great pad rotation.



CENTER VENTILATED COOLING CHANNEL
Dissipates heat away from the center of pad, reducing temperature, increasing durability.



DUAL LAYER DESIGN
Dual layers reduce heat transfer & lateral movement for less foam fatigue.

MICROFIBER & FOAM HDO® PADS

BACKGROUND

Designed for long throw polishers specifically, the heavy duty orbital (HDO) line was created to offer more durable and performance enhancing characteristics. The dual layer design allows these pads to capture all the benefits that come with not only a tapered pad, like anti-roll and backing plate protection, but the benefits of even compression like an exact fit pad. It features the benefits of a thin pad, such as increased power and reduced pad motion, while still retaining the proper weight and balance for proper rotation.

HDO® PADS AGGRESSION CHART

Each bar color coordinates with the applicable pad color.

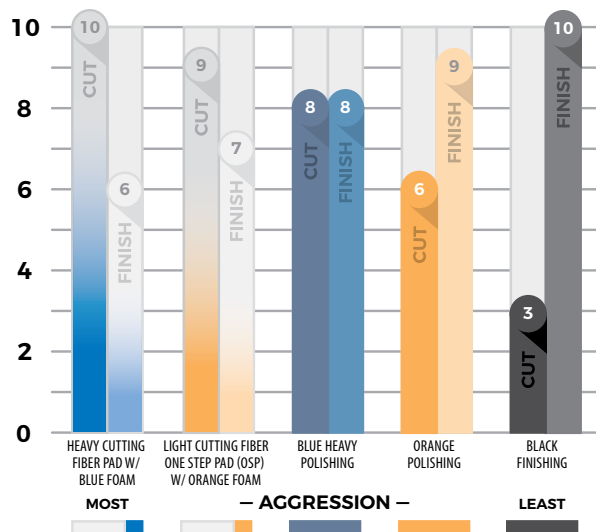

HDO[®] PADS

MICROFIBER & FOAM

RECOMMENDED TOOLS: LONG THROW DA 4 MINI LONG THROW 5

HDO [™] Microfiber & Foam Pads	Description	Thickness	6-1/2"	5-1/2"	3-1/2"
			Fits 6" Backing Plate	Fits 5" Backing Plate	Fits 3" Backing Plate Recommended Tools 5
	Heavy Cutting Fiber Pad w/ Blue Interface	1/2"	HDO-650F	HDO-550F	HDO-350F
	Light Cutting Fiber One Step Pad (OSP) w/ Orange Interface		HDO-650F-OSP	HDO-550F-OSP	HDO-350F-OSP
	Blue Heavy Polishing Pad	1"	HDO-93650	HDO-93550	HDO-93350
	Orange Polishing Pad		HDO-23650	HDO-23550	HDO-23350
	Black Finishing Pad		HDO-73650	HDO-73550	HDO-73350

PROFILE

Attachment method:
Hook & loop

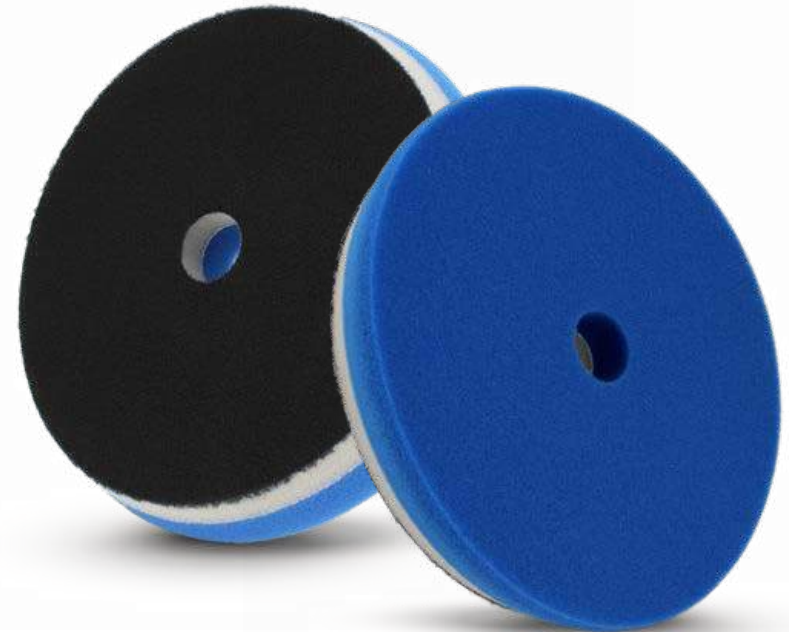
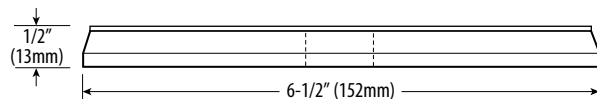
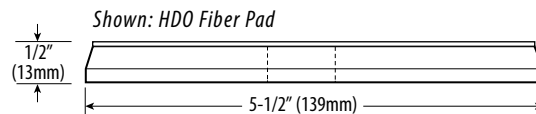
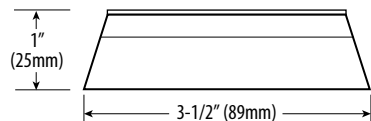
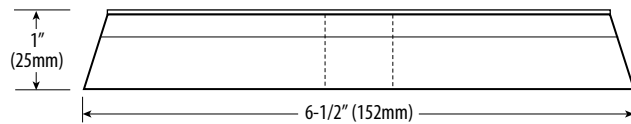



TAPERED EDGE
Prevents pad rolling & provides great pad rotation.



CENTER VENTILATED COOLING CHANNEL
Dissipates heat away from the center of pad, reducing temperature, increasing durability.



SDO FORMULATION
SDO foams provide maximum durability & consistency.

LOW LINT WOOL & FOAM SDO™ PADS

BACKGROUND

Standard Duty Orbital (SDO) pads have been designed to offer the same great engineered foams as the HDO® line without the dual layer construction and are suitable for all DA polishers with a center ventilated backing plate. The center hole provides a tunnel to release and dissipate heat from the foam; reducing surface temperatures making it less likely to damage the paint.

SDO PADS AGGRESSION CHART

Each bar color coordinates with the applicable pad color.

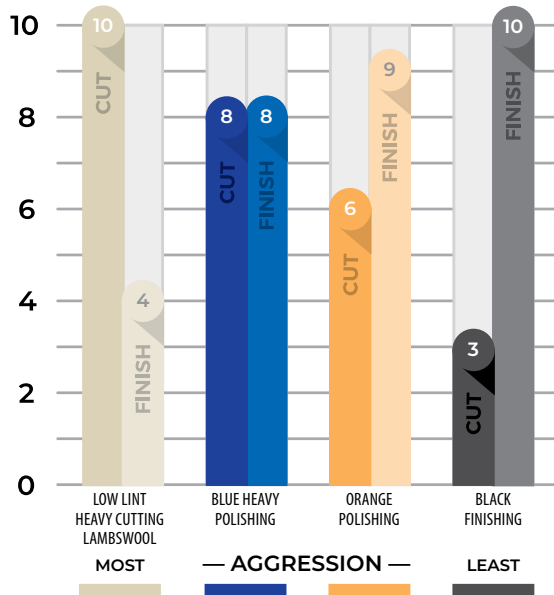

SDO™ PADS

LOW LINT WOOL & FOAM

RECOMMENDED TOOLS: DA **1** FORCE ROTATION **3** LONG THROW DA **4** MINI LONG THROW **5**

Low Lint Wool & Foam	Description	Thickness	6-1/2" Fits 6" Backing Plate	6" Fits 6" Backing Plate	5-1/2" Fits 5" Backing Plate	5-1/4" Fits 5" Backing Plate	3-1/2" Fits 3" Backing Plate	3-1/4" Fits 3" Backing Plate
	Low Lint Wool Heavy Cutting 1/2" Knitted Lambswool w/ No Foam Backing	1/2"		LL-600-EC		LL-525-EC		LL-325-EC
	Blue Heavy Polishing Pad	7/8"	SD0-92650		SD0-92550		SD0-92350	
	Orange Polishing Pad		SD0-22650		SD0-22550		SD0-22350	
	Black Finishing Pad		SD0-72650		SD0-72550		SD0-72350	

PROFILE

Attachment method:

Hook & loop

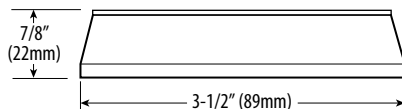
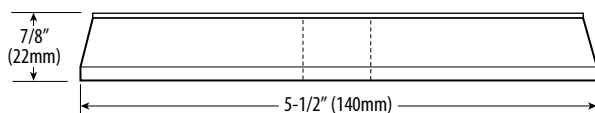
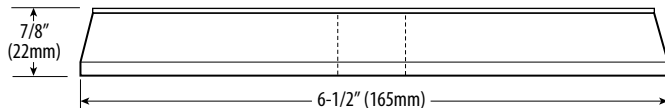



TAPERED EDGE
Prevents pad rolling and provides great pad rotation.



CENTER VENTILATED COOLING CHANNEL
Dissipates heat away from the center of pad, reducing temperature, increasing durability.



ENGINEERED FOAM
Small cells & dense construction uses less polish for quicker results.

BLUE HYBRID WOOL & FOAM FORCE™ PADS

FEATURING HYBRID FOAM TECHNOLOGY

BACKGROUND

Force™ hybrid foams are specifically engineered with small cells and dense, robust construction to maximize performance when used on a forced rotation machine polisher. This results in faster correction time as more polish stays on the working surface rather than being absorbed into the foam.

FORCE PADS AGGRESSION CHART



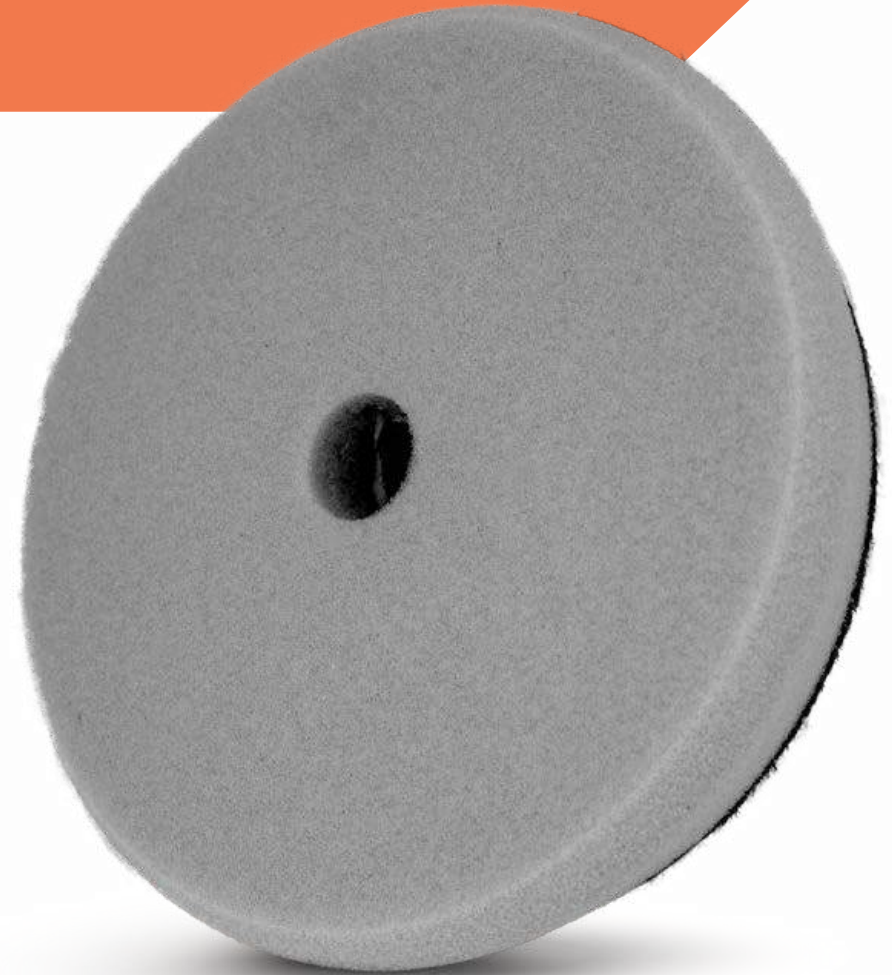
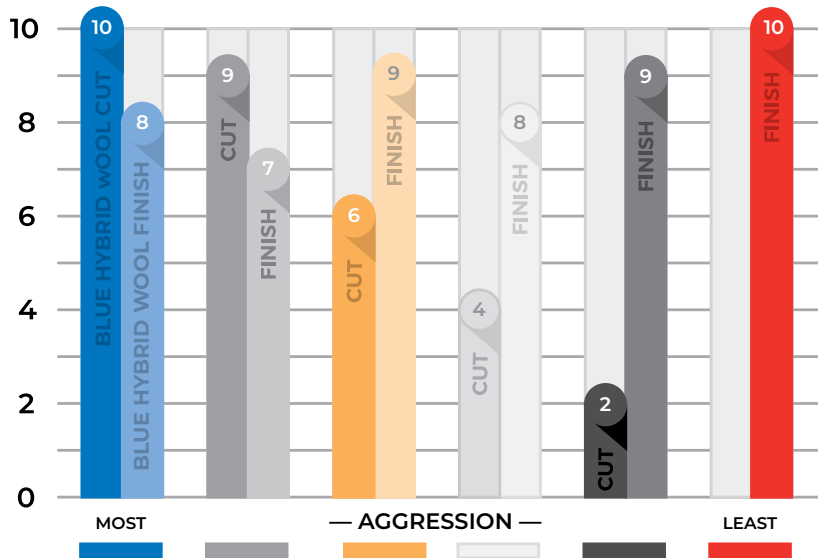

Each bar color coordinates with the applicable pad color.



FORCE™ PADS

FEATURING HYBRID FOAM TECHNOLOGY

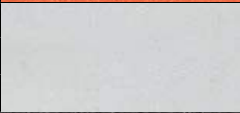
RECOMMENDED TOOLS: ROTARY 2 FORCED ROTATION 3 MICRO POLISHER 6

Force Pads	Description	Thickness	6-1/2"	5-1/2"	3-1/2"	2-3/8"	1-5/8"
			Fits 6" Backing Plate	Fits 5" Backing Plate	Fits 3" Backing Plate	Fits 2" Backing Plate	Fits 1-1/4" Backing Plate
			Recommended Tool 3	Recommended Tool 3	Recommended Tool 2	Recommended Tool 6	Recommended Tool 6
	Blue Hybrid Wool Pad	1"	HYB-159* 6-1/4" diameter	HYB-133* 5-1/4" diameter	HYB-80-1* 3-1/4" diameter		
	Grey Heavy Cutting Foam Pad	11/16"				FR-HGrey 2"	FR-HGrey 1"
		7/8"			FR-HGrey 3.5"		
		1-1/4"	FR-HGrey 6.5"	FR-HGrey 5.5"			
	Orange Cutting Foam Pad	11/16"				FR-HOrange 2"	FR-HOrange 1"
		7/8"			FR-HOrange 3.5"		
		1-1/4"	FR-HOrange 6.5"	FR-HOrange 5.5"			
	White Polishing Foam Pad	11/16"				FR-HWhite 2"	FR-HWhite 1"
		7/8"			FR-HWhite 3.5"		
		1-1/4"	FR-HWhite 6.5"	FR-HWhite 5.5"			
	Black Finishing Foam Pad	11/16"				FR-HBlack 2"	FR-HBlack 1"
		7/8"			FR-HBlack 3.5"		
		1-1/4"	FR-HBlack 6.5"	FR-HBlack 5.5"			
	Red Waxing Foam Pad	11/16"				FR-HRed 2"	FR-HRed 1"
		7/8"			FR-HRed 3.5"		
		1-1/4"	FR-HRed 6.5"	FR-HRed 5.5"			

PROFILE

Attachment method:
Hook & loop

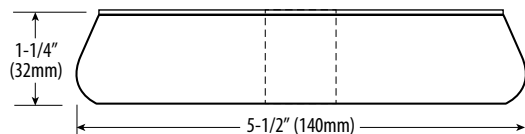
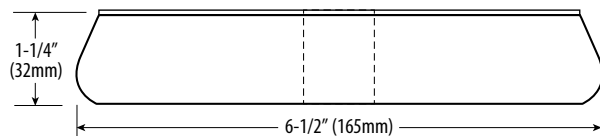



IMPROVES CONTROL

Improves control and user experience.



PREVENTS PAD SKIPPING

Convuluted foam reduces surface friction allowing operator to run pad flat on surface.



CREATES LESS HEAT

Reduced surface contact resulting in less friction generated heat.

WAFFLE PRO PADS

BACKGROUND

Waffle foam pads are built to maximize performance, minimize heat, and reduce present pad skipping. The wavy waffle texture allows air flow underneath the pad to release heat. Operator control is improved by the features of our convoluted design.

WAFFLE PRO AGGRESSION CHART

Each bar color coordinates with the applicable pad color.

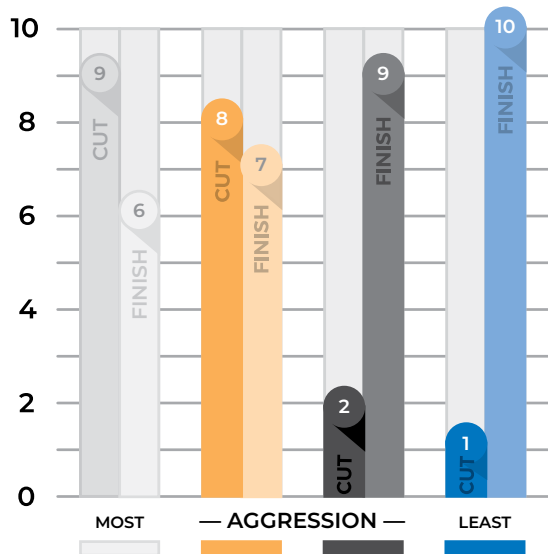





WAFFLE PRO PADS

RECOMMENDED TOOLS: DA 1 ROTARY 2

CUTBACK PROFILE

Buffback pads allow for the ability to access hard to reach areas while protecting the back plate.

Waffle Pro Pads	Description	Thickness	6-1/2" Fits 6" Backing Plate	5-1/2" Fits 5" Backing Plate	3-3/4" Fits 3-1/4" Backing Plate	3-1/2" Fits 3" Backing Plate
	White Compounding Foam Pad	7/8"	WP-6265-152MM	WP-6255-130MM	WP-62375-83MM	WP-6235-76MM
	Orange Heavy Cutting Foam Pad		WP-2265-152MM	WP-2255-130MM	WP-22375-83MM	WP-2235-76MM
	Black Finishing Foam Pad		WP-7265-152MM	WP-7255-130MM	WP-72375-83MM	WP-7235-76MM
	Blue Finishing Foam Pad		WP-9265-152MM	WP-9255-130MM	WP-92375-83MM	WP-9235-76MM

PROFILE

Attachment method:
Hook & loop

Backing plate 43-125DAR

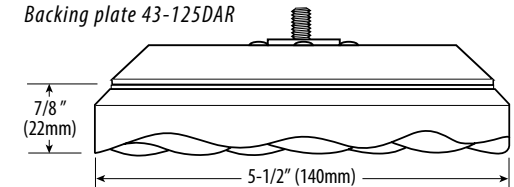

STRAIGHT CUT PROFILE

Straight cut waffle pads offer an economic option in sizes for OEM and body shop use.

Waffle Pro Pads	Description	Thickness	8" Fits 7" Backing Plate	3-1/4" Fits 3-1/2" Backing Plate
			Recommended Tool 2	
	White Compounding Foam Pad	7/8"	WP-62800	WP-62325-1
		1-1/2"	WP-66800*	
	Orange Heavy Cutting Foam Pad	7/8"		WP-22325-1
		1-1/2"		
	Black Finishing Foam Pad	7/8"	WP-72800	WP-72325-1
		1-1/2"	WP-76800*	
	Blue Finishing Foam Pad	7/8"	WP-92800	WP-92325-1
		1-1/2"	WP-96800*	

PROFILE

Attachment method:
Hook & loop

Backing plate 43-175

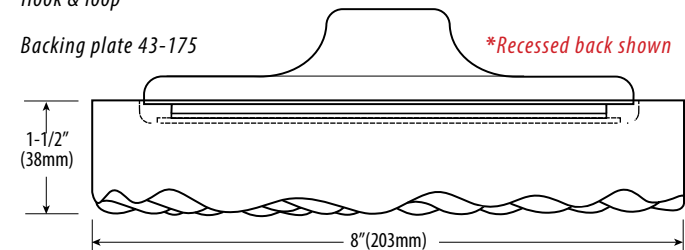



SPECIALTY FOAM

Designed to use with water based compounds and polishes.



CLOSED CELL FOAM

High density foam restricts absorption of compounds and polish.



EFFICIENT

Closed cell foam keeps polish on the surface to increase performance.

HYDRO TECH FOAM

BACKGROUND

Hydro-tech uses specialty engineered foams for use with water-based compounds and polishes. These closed cell foams reduce polish absorption into the pad keeping polish on the working surface for optimum performance of both pad and polish. High strength, tear resistant foam.

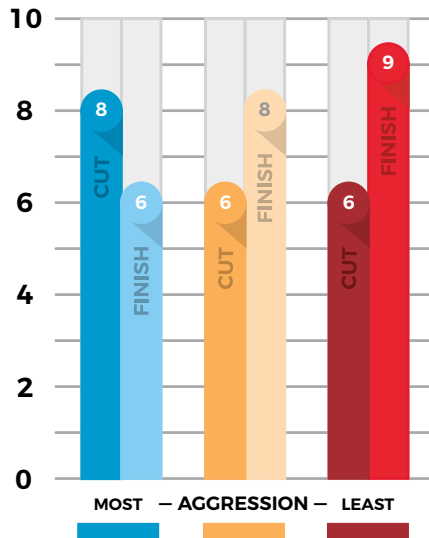

HYDRO-TECH AGGRESSION CHART

Each bar color coordinates with the applicable pad color.



HYDRO-TECH PADS

RECOMMENDED TOOLS: DA 1 ROTARY 2

Hydro-Tech Foam Pads	Description	Thickness	6-1/2"	5-1/2"
			Fits 6" Backing Plate	Fits 5" Backing Plate
	Cyan Heavy Polishing Foam Pad	7/8"	H20-9265-152MM	H20-9255-130MM
		1-1/4"	H20-9165-152MM	H20-9155-130MM
	Tangerine Light Polishing Foam Pad	7/8"	H20-2265-152MM	H20-2255-130MM
		1-1/4"	H20-2165-152MM	H20-2155-130MM
	Crimson Ultra Finishing Foam Pad	7/8"	H20-1265-152MM	H20-1255-130MM
		1-1/4"	H20-1165-152MM	H20-1155-130MM

PROFILE

Attachment method: Hook & loop

Backing plate 45-936

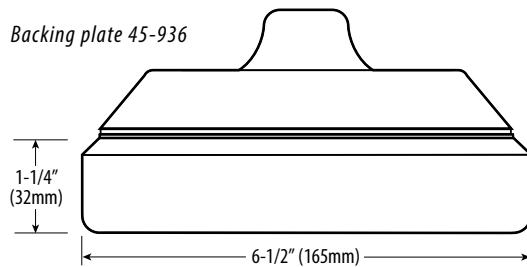

Backing plate 45-929

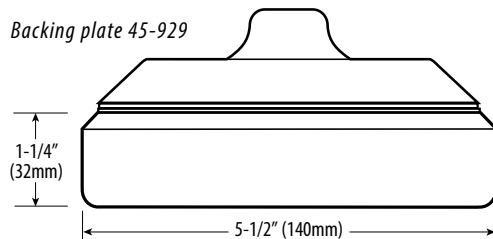

Backing plate 43-125DAR

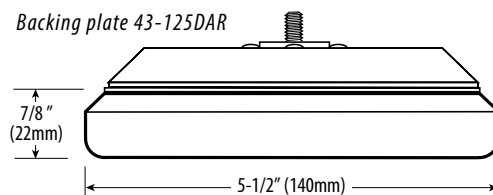



PRECISION SIZING

Minimal overhang for precision polishing and even pressure.



SPECIALTY BLEND OF MATERIAL

Provides an amazing finishing ability resulting in a haze free luster.



FOAM INTERFACE

Foam provides greater durability and is optimized for user experience.

MICROFIBER PADS

BACKGROUND

With years of testing, a complete line of 3 microfiber pads were created to tackle any job with a DA polisher. Using specific blends of microfiber and special bonding materials, we created these pads to have durability and longevity that is tough to compete with. Each pad offers its own unique blend of microfiber, paired with the appropriate foam interface to suite each purpose.

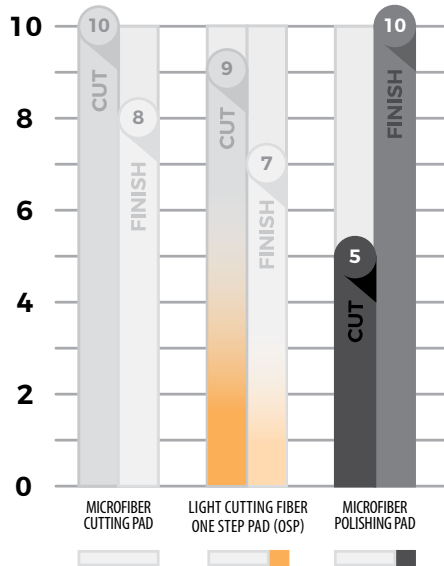

MICROFIBER AGGRESSION CHART

Each bar color coordinates with the applicable pad color.



MICROFIBER PADS

RECOMMENDED TOOLS: DA 1

Microfiber Pads	Description	Thickness	6-1/4" Fits 6" Backing Plate	5-1/4" Fits 5" Backing Plate	3-1/4" Fits 3" Backing Plate
	Microfiber White Cutting Pad (No center hole)	1/2"	MF-625 CUT	MF-525 CUT	MF-325 CUT
	Light Cutting One Step Pad (OSP) (No center hole)		MF-625 OSP	MF-525 OSP	MF-325 OSP
	Microfiber Black Polishing Pad (No center hole)		MF-625 POL	MF-525 POL	MF-325 POL

PROFILE

Attachment method: Hook & loop

Backing plate 43-148DAR

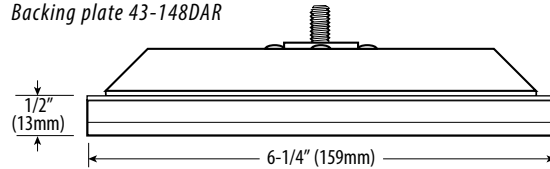

Backing plate 43-125DAR

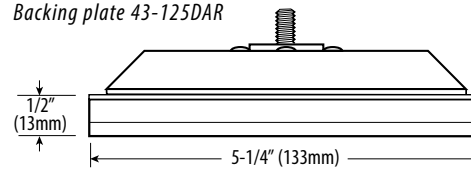

MICROFIBER MINI PADS

Mini microfiber pads will make the most of every usable surface, making it possible to access all those tough to reach areas.

RECOMMENDED TOOLS: ROTARY 2 MINI LONG THROW 5 MICRO POLISHER 6

Mini Microfiber Pads	Description	Thickness	2-1/4" Fits 2" Backing Plate	1-1/2" Fits 1" or 1-1/4" Backing Plate
	Microfiber White Cutting Pad (No Center Hole)	1/2"	MF-225 CUT	MF-150 CUT

PROFILE

Attachment method: Hook & loop

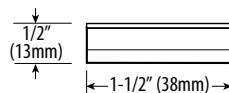
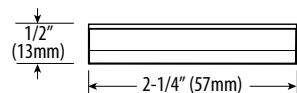



BETTER EDGE

Beveled edge allows access under mirrors, door handles, trim, and more.



RECESSED BACK

Precision alignment for balance & eliminates the possibility of contact with a backing plate.



MACHINE WASHABLE

Safely clean pads without affecting performance and durability.

BETTER EDGE PADS

BACKGROUND

This foam is manufactured using the finest engineered foams that are specifically designed for compounding, polishing, finishing, and waxing the newer, harder, scratch-resistant finishes. They are thermally reticulated with an open cell structure, which allows air to circulate through the pad, thus reducing heat buildup.

BETTER EDGE AGGRESSION CHART

Each bar color coordinates with the applicable pad color.

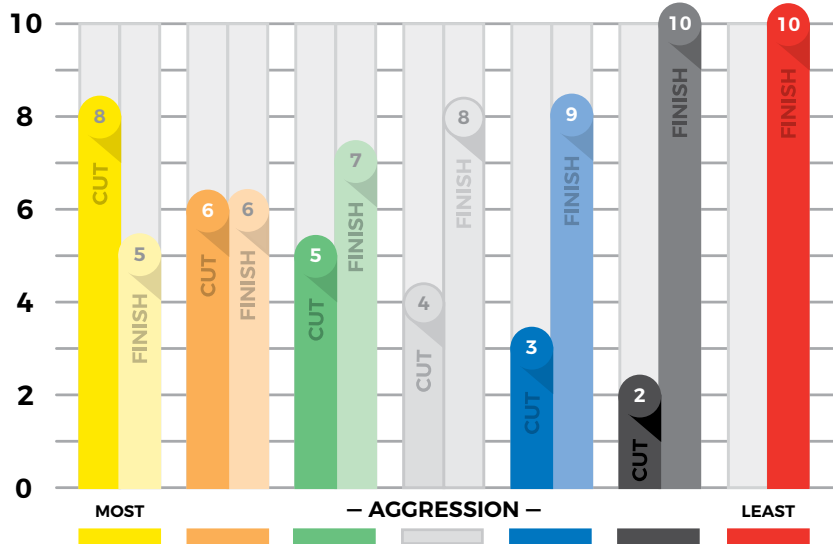

BETTER EDGE PADS

RECOMMENDED TOOLS: ROTARY 2

Better Edge Foam Pads	Description	Thickness	8-1/2" Fits 7" Backing Plate
	Yellow Cutting Recessed Foam Pad	1-1/2"	39-702
	Orange Light Cutting Recessed Foam Pad		39-701
	Green Heavy Polishing Recessed Foam Pad		39-703
	Soft White Polishing Recessed Foam Pad		39-706
	Blue Light Polishing Recessed Foam Pad		39-704
	Black Finishing Recessed Foam Pad		39-705
	Red Final Finishing/Waxing Recessed Foam Pad		39-709

PROFILE

Attachment method:

Hook & loop

Backing plate 43-175M

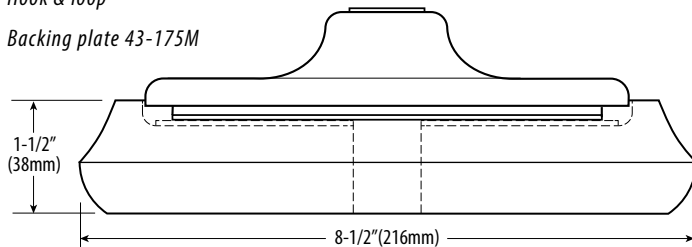



SMOOTH HANDLING

Buffers similar to a wool pad without the lint.



INCREASED BUFFING SURFACE

9x the potential contact compared to a conventional flat pad.



CREATES LESS HEAT/BUILD UP

Independent 'foam fingers' improve air flow and polish build up.

TUFTED FOAM PADS

BACKGROUND

The exclusive tufted foam pad design features hundreds of tiny "foam fingers" that are tufted into the backing material in a manner similar to a wool pad.

TUFTED FOAM AGGRESSION CHART

Each bar color coordinates with the applicable pad color.

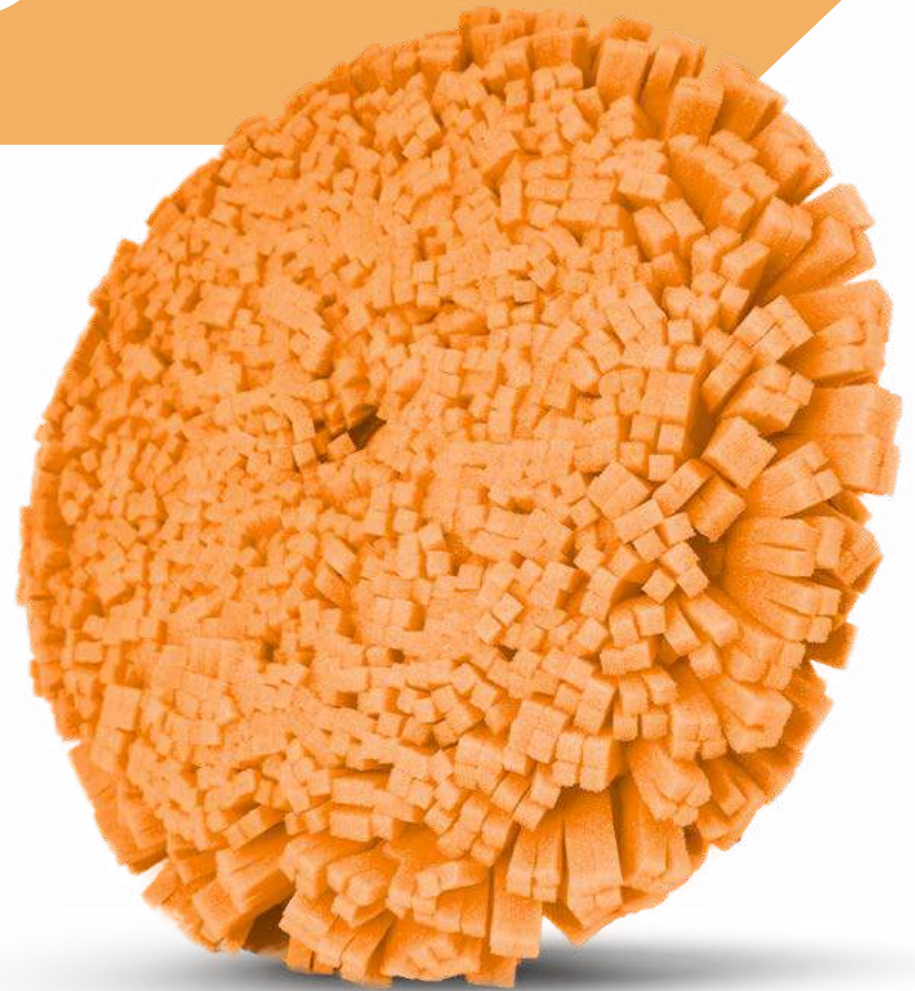
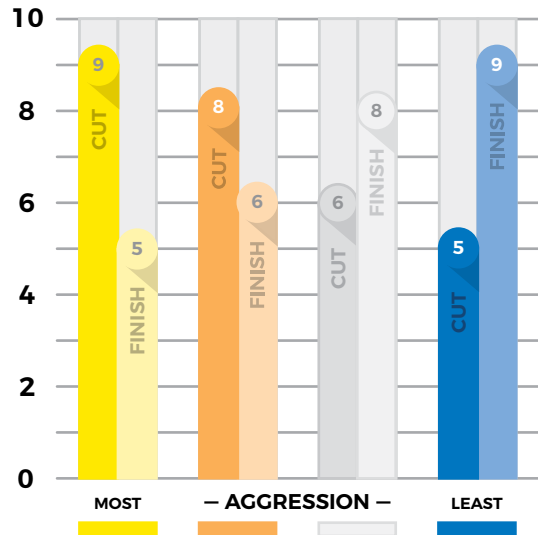

TUFTED FOAM PADS

RECOMMENDED TOOLS: ROTARY 2

Tufted Foam Pads	Description	Thickness	7-1/2" Fits 7" Backing Plate
	Yellow Tufted Cutting Foam Pad	1"	45-508
	Orange Tufted Light Cutting Foam Pad		45-208
	White Tufted Polishing Foam Pad		45-608
	Blue Tufted Finishing Foam Pad		45-908

PROFILE

Attachment method:

Hook & loop

Backing plate 43-175M

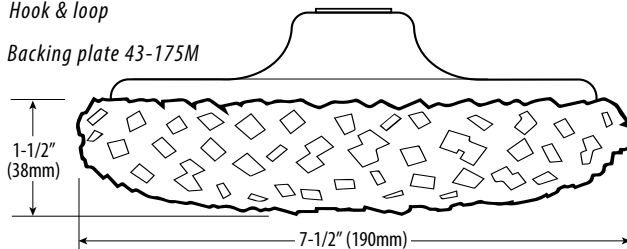



ACCURATE & PRECISE
Precision tapered profile is ideal for tight areas.



ROBUST HYBRID FOAMS
Dense European foams allow for wide range of aggression.



EXACT FIT BACKING
Perfect fit every time with easy to center loop.

HOOK & LOOP MINI PADS

BACKGROUND

Machine polishers hitting the market keep getting smaller to meet the needs of professional detailers and technicians. Whether it's small trim pieces, motorcycles, scoops or even interior pieces, more precise tools are required. Our mini pads offer a variety of colors and sizes to fit any mini machine, whether rotary or DA. The tapered design prevents pad deformation, and the precision edge is perfect for detailed edge work.

FORCE PADS AGGRESSION CHART

This chart is applicable for Force pads.

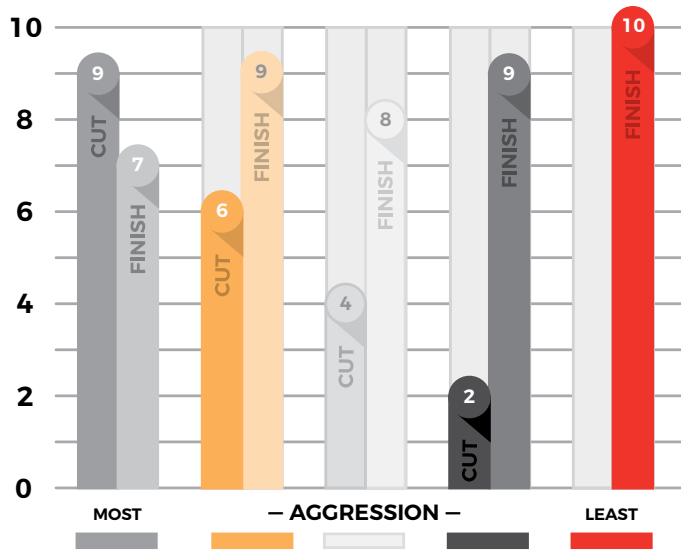

MICROFIBER AGGRESSION CHART

This chart is applicable for Microfiber pads.

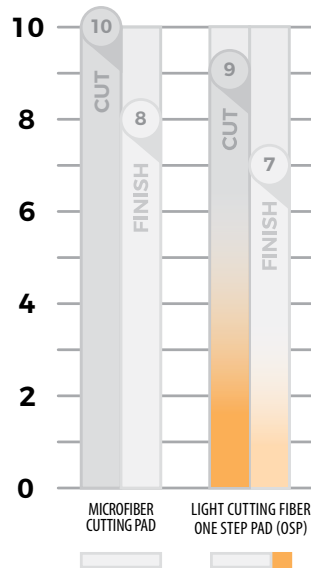

MINI PADS

HOOK & LOOP

FORCE MINI PADS

The Force mini pads offer an expansive pad lineup for those tight spaces.

RECOMMENDED TOOLS: ROTARY 2 MICRO POLISHER 6

Force Mini Pads	Description	Thickness	2-3/8" Fits 2" Backing Plate	1-5/8" Fits 1" or 1-1/4" Backing Plate
	Grey Heavy Cutting Foam Pad	11/16"	FR-HGrey 2"	FR-HGrey 1"
	Orange Cutting Foam Pad		FR-HOrange 2"	FR-HOrange 1"
	White Polishing Foam Pad		FR-HWhite 2"	FR-HWhite 1"
	Black Finishing Foam Pad		FR-HBlack 2"	FR-HBlack 1"
	Red Waxing Foam Pad		FR-HRed 2"	FR-HRed 1"



MICROFIBER MINI PADS

Mini microfiber pads will make the most of every usable surface, making it possible to access all those tough to reach areas.

RECOMMENDED TOOLS: ROTARY 2 MINI LONG THROW 5 MICRO POLISHER 6

Mini Microfiber Pads	Description	Thickness	2-1/4" Fits 2" Backing Plate	1-1/2" Fits 1" or 1-1/4" Backing Plate
	Microfiber White Cutting Pad (No Center Hole)	1/2"	MF-225 CUT	MF-150 CUT





**ITS ALL
ABOUT THE
DETAILS**

PREMIUM WOOL PADS

KNITTED

Knitted Quick Tip:

Washing the lambswool removes the natural oils in the wool, adding cutting ability and ability for abrasives to cling to the wool fibers.

A GRADE ABOVE THE REST

The LC knitted wool pads are the finest in their class, created from only the highest grade wool and blend of materials. Compiled of a number of proprietary and different blended pads, we offer wool pad products available nowhere else in the world. Our knitted wool pads combine the performance benefits of traditional lambswool with the ability to blend materials to suit specific cutting or finishing needs, all while ensuring a consistent quality from pad to pad.

Knitted pads reduce the amount of shedding or linting compared to traditional wool pads. Our signature foamed wool pads are known around the world, and continue to gain popularity year over year. We pride ourselves on finding wool pad solutions from industrial applications to detailing and for all types of machines.



SIGNATURE FOAMED WOOLS

Ideal for body shop, detailing, OEM and industrial applications.

- **One-Step Compounding**

Aggressively removes P1500 scratches and finishes to high gloss in one step. Cuts like natural sheepskin but finishes like a foam pad, leaving a lustrous finish with no haze.

- **Nano Foamed Wool Technology**

Interlocking the wool fibers, a polyurethane foam is blended and embedded in the base of the knitted wool, creating more surface area and a reduction in pile flattening.

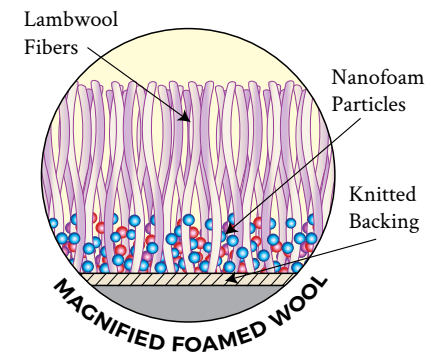

PREWASHED WOOL

Used in a variety of markets or applications, our premium knitted wool pads come in a variety of blends that make these pads ideal for any industrial application.

- **Reduced Lint**

Work cleaner and reduce contamination of the environment in body shop and OEM applications where it matters most.

- **Consistent Quality & Construction**

Manufacturing process ensures uniform material unlike natural sheepskin which varies in consistency. Higher density product makes the material resist “caking & matting”.



DURABLE BACKING

More durable than natural backing material, allowing more washings.



PREMIUM BLENDS

Signature wool blends for fast, effective cutting with great finishing qualities.



REDUCED LINTING

Knitted pads lint less making your shop or work area cleaner.

KNITTED WOOL PADS

BACKGROUND

As one of the first pads ever offered by Lake Country, we've tested and developed the most premium knitted wool pads. Similar to natural sheepskin pads, these have an increased cutting ability, but unlike natural sheepskin the performance will be consistent from pad to pad. Along with more variety of sizes, these pads also lint much less than a traditional tufted wool pad.

KNITTED LINE AGGRESSION CHART

Each bar color coordinates with the applicable pad color.

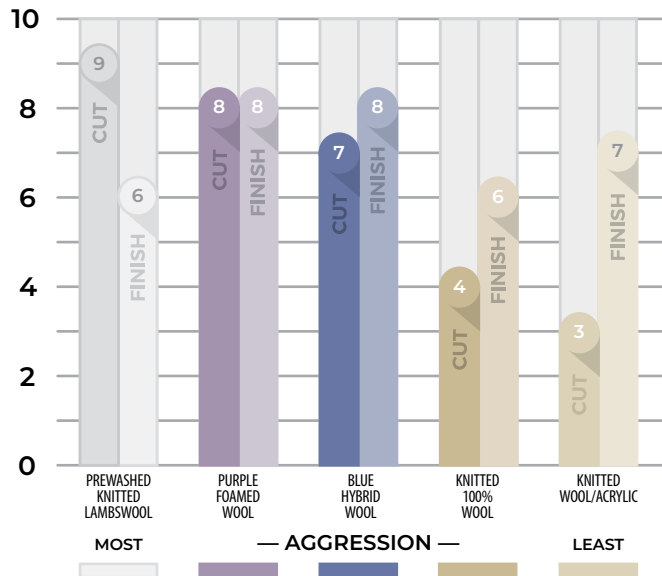

PREWASHED LAMBSWOOL

KNITTED WOOL

RECOMMENDED TOOLS: ROTARY 2

Knitted with only 100% lambswool, this is the most aggressive option in our knitted pad line. Our apparel grade wool is plush and consistent to offer the desired result time and time again. The prewashing process removes natural oils from the wool fibers, providing increased cutting with a more plush and dense appearance.

Prewashed Knitted Lambswool	Description	Size (W x H)	Part Number	Matching Backing Plate Size
	Prewashed White Lambswool Knitted Polishing Pad	3-1/2 x 3/4"	77-213-1	3"
		4-1/4 x 3/4"	77-214-1	4" or 3"
		5 x 3/4"	77-215-1	4"
	Prewashed White Lambswool Knitted Polishing Pad with Center Hole	6 x 3/4"	77-216	5"
		6-1/2 x 3/4"	77-2165	5"
		7 x 3/4"	77-217	6"
		7.5 x 3/4"	77-2175	6"

PROFILE

Attachment method:

Hook & loop

Backing plate 43-160WH

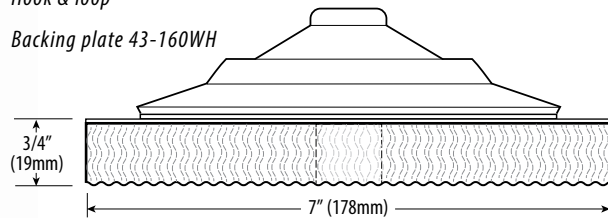

Backing plate 43-125WH

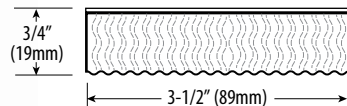
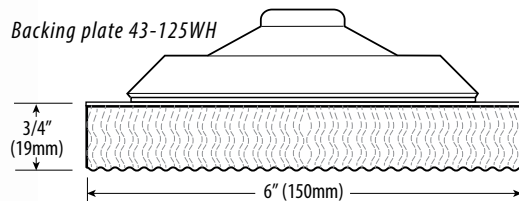

PURPLE FOAMED WOOL

KNITTED WOOL

RECOMMENDED TOOLS: DA 1 ROTARY 2 FORCE ROTATION 3

The purple foamed wool is a staple in the detail, OEM, and industrial markets alike. The proprietary foaming process helps hold the fibers together, creating a cushioned feel, holding abrasives to the surface, and adding an increased gloss and finishing ability. The patented nanofoam process encapsulates fibers at the base of the lambswool with microscopic polyfoam particles. Easily remove and level P1500 grit scratches, but still leave the finish of a foam pad, reducing holograms or compounding swirls.

Purple Foamed Wool	Description	Size (W x H)	Part Number	Matching Backing Plate Size
	Purple Foamed Wool Buffing/Polishing Pad	3 x 1"	58-423-1	3"
		3-1/4 x 1/4"	58-12325-1	
		3-1/2 x 1"	58-4235-1	
		4-1/4 x 1"	58-42425-1	4 or 3"
		5 x 1"	58-425-1	5"
		5-1/2 x 1/4"	58-1255-1	
		5-1/2 x 1"	58-4255-1	
		6 x 1"	58-426	
		6-1/2 x 1/4"	58-1265-1	6"
		Purple Foamed Wool Buffing/Polishing Pad with Center Hole	5-1/4 x 3/4"	58-32525WH-1
6-1/4 x 3/4"	58-32625WH-1		6"	
6-1/2 x 1"	58-4265			
7 x 1"	58-427			
7-1/2 x 1"	58-4275		7" or 6-1/4"	

PROFILE

Attachment method:

Hook & loop

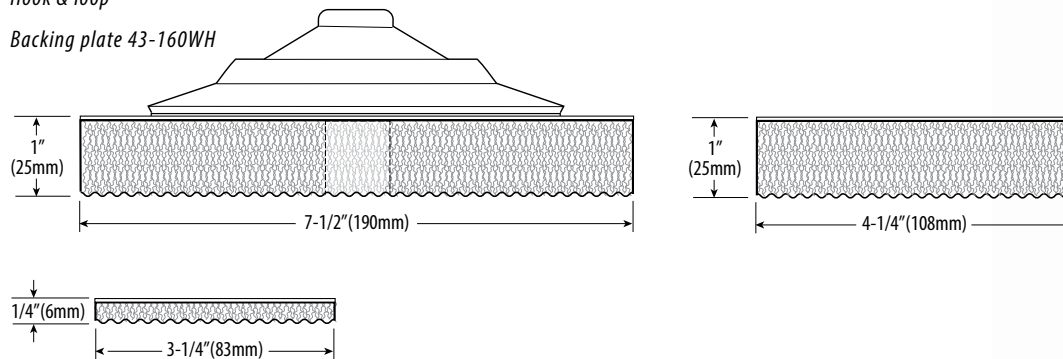

Backing plate 43-160WH



BLUE HYBRID KNITTED WOOL

RECOMMENDED TOOLS: ROTARY 2 FORCE ROTATION 3

With the same great technology of our purple foamed wool pad, the Hybrid wool has a higher foam content for increased firmness and an even better finish. Offered in a 1" pile, this pad was originally designed as a cutting pad for gear driven and forced rotation polishers. The foamed wool fibers resist or reduce caking and matting down.

Blue Hybrid Wool	Description	Size (W x H)	Part Number	Matching Backing Plate Size
	Blue Hybrid Wool	3-1/4 x 1"	HYB-80-1	3"
		4-1/4 x 1"	HYB-108-1	4" or 3"
	Blue Hybrid Wool with Center Hole	5-1/4 x 1"	HYB-133	5"
		6 x 1"	HYB-150	6"
		6-1/4 x 1"	HYB-159	6"
		7-1/2 x 1"	HYB-178	7" or 6-1/4"

PROFILE

Attachment method:

Hook & loop

Backing plate 43-160WH

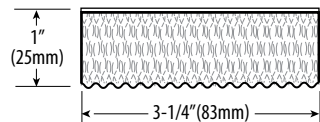
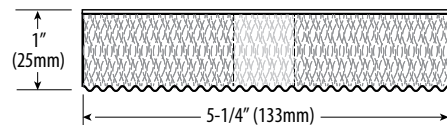
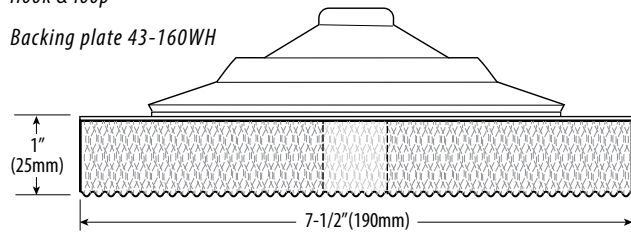

100% CURVED WOOL

KNITTED WOOL

RECOMMENDED TOOLS: ROTARY 2

This pad offers the same great features of our traditional knitted wool pads in a full sized curved version for rotary use only. Knitted wool works great for metal, gelcoat and paint polishing. This material works exceptionally well for polishing aluminum. Knitted into a synthetic backing material, these pads offer a more durable construction allowing for more cleaning or washings.

100% Wool Knitted	Description	Size (W x H)	Part Number	Matching Backing Plate Size
	100% Wool Knitted Polishing Pad	7-1/2 x 1-1/2"	41-725	7" or 6-1/4"

PROFILE

Attachment method:

Hook & loop

Backing plate: 43-175M

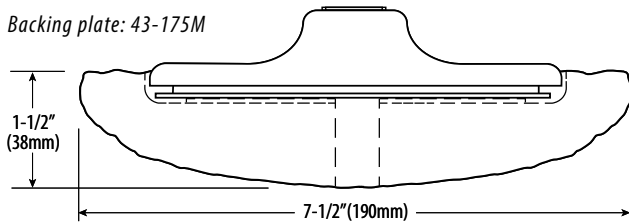

CURVED WOOL/ACRYLIC KNITTED WOOL

RECOMMENDED TOOLS: ROTARY 2

An even blend of wool and synthetic acrylics make this pad slightly less aggressive than 100% wool, resulting in a higher gloss and finish. Works well for medium duty cutting and polishing applications.

Knitted Wool/Acrylic	Description	Size (W x H)	Part Number	Matching Backing Plate Size
	Wool/Acrylic Blend Knitted Polishing Pad	7-1/2 x 1"	41-625	7" or 6-1/4"

PROFILE

Attachment method:

Hook & loop

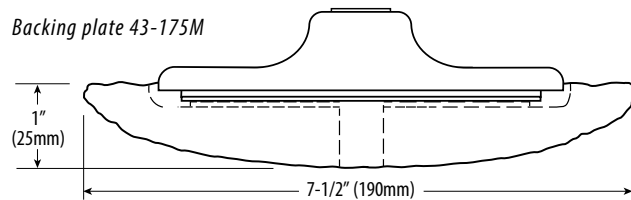

Backing plate 43-175M



LOW LINT KNITTED LINE

RECOMMENDED TOOLS: DA 1 ROTARY 2 FORCE ROTATION 3 LONG THROW DA 4 MINI LONG THROW 5

Premium low lint pads are a knitted prewashed lambswool paired with a foam interface for maximum comfort, performance and overall user feel/experience. Significant testing went into the design to determine the best weight & wool pile height to maximize this pad for peak performance on any type of machine.

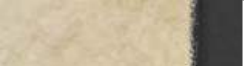
Low Lint Lambswool	Description	Size (W x H)	Part Number	Matching Backing Plate Size
	Low Lint Prewashed Knitted Lambswool 1/2" Wool w/ No Interface	3-1/4 x 1/2"	LL-325-EC	3"
		5-1/4 x 1/2"	LL-525-EC	4"
		6 x 1/2"	LL-600-EC	5"
		8 x 1/2"	LL-800-EC	7"
	Low Lint Prewashed Knitted Lambswool 1/2" Wool 3/8" Foam w/ Interface	3-1/4 x 7/8"	LL-92325	3"
		5-1/4 x 7/8"	LL-92525	4"
		6 x 7/8"	LL-92600	5"
	Low Lint Prewashed Knitted Lambswool 1/2" Wool 3/8" Soft Foam w/ Interface	8 x 7/8"	LL-72800	7"

PROFILE

Attachment method:

Hook & loop

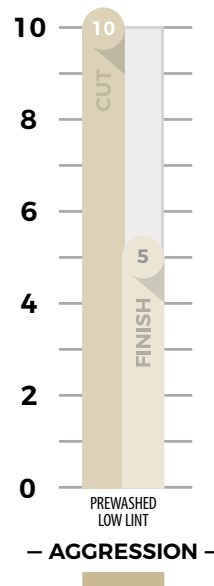
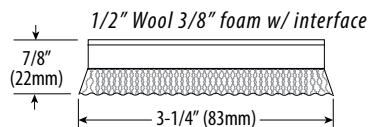
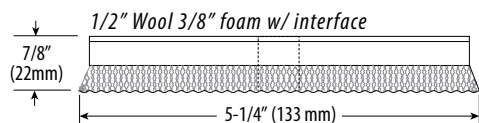
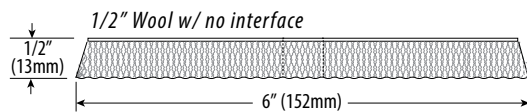
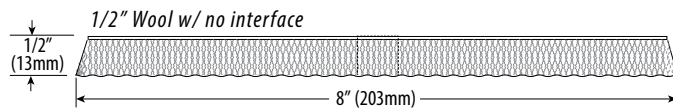

STEAMED/UNSTEAMED WOOL PADS

TUFTED

Tufted Wool Tip:

Wash or spur prior to first use to lower initial blow-off of lint.

A GRADE ABOVE THE REST

Tufted wools come in what seems like an endless variety of sizes, blends, and even construction. Lake Country is the only wool pad manufacturer to offer both steamed and unsteamed wool pads to fit anyone's need or intended purpose. Each style of pad offers different performance and feel, creating a following for both styles throughout the world.

Steamed pads typically have less wool material, and are lighter in weight. The steaming process swells or blooms the wool strands to fill in the pad, and lock in some of the loose fibers of the pad. This helps reduce the linting of the wool and makes the strands stay more vertical.

Unsteamed wool pads are sewn with more wool which provides more material to cut. Wool strands lie flat or horizontal so leveling sand scratches is easy. We offer a number of blends, so the cut and finish can be altered to the user's preference.



STEAMED PADS (NEW)

By steaming wool, the tufted wool yarn strands “bloom” with heat and moisture providing a full, plush feeling.

- **Larger Strands**
During the steaming process, the strands bloom and swell.
- **Less Initial Blow-Off**
Steamed wool reduces the amount of wool that is initially shed from the pad during first use.
- **Look and Feel**
Visually the pad appears more plush with a firmer feel.



UNSTEAMED PADS (TRADITIONAL)

The traditional build of an unsteamed pad includes more strands per square inch and less processing to the raw material.

- **More Aggressive**
Due to the tighter sewn strands, these pads are more aggressive in their function.
- **More Initial Blow-Off**
During first time use there will be a greater amount of blow-off. There will be minimal shedding for the remaining life of the pad.



QUICK CUTTING

Engineered wool and other yarns are the fastest cutting products.



DURABLE AND STRONG

Signature backing construction and material blends offer a pad with extended durability.



CURVED EDGE

Allows for perfect pad alignment while protecting the working surface.

HOOK & LOOP TUFTED WOOL

BACKGROUND

Tufted wool is a traditional and aggressive cutting material used in pad construction that has been used in the industry for years, making it one of the best selling pads overall. Tufted wool is available in a variety of options.

TUFTED WOOL AGGRESSION CHART

Each bar color coordinates with the applicable pad color.

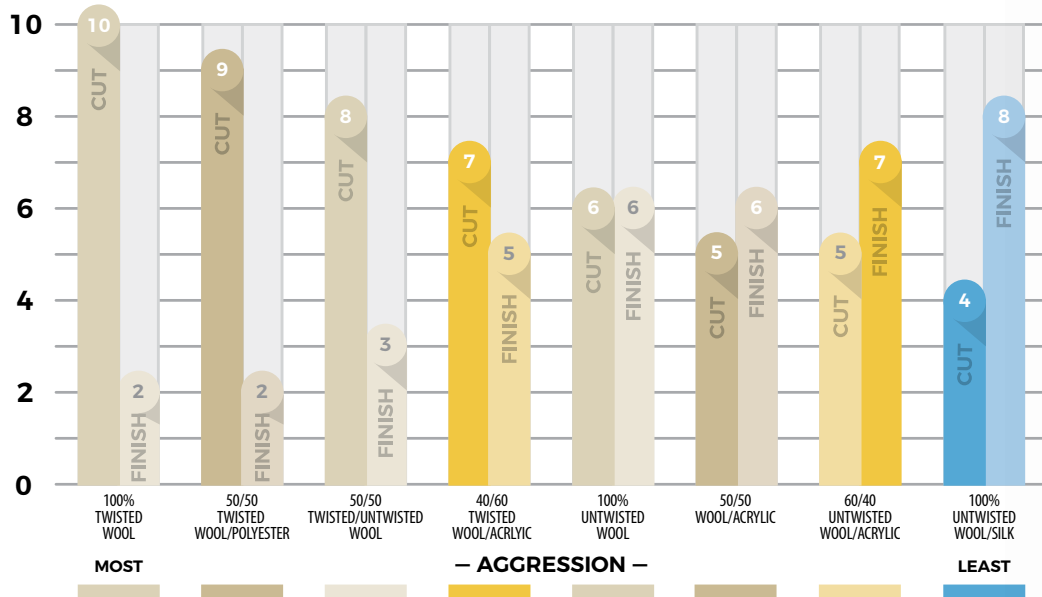

100% TWISTED WOOL

RECOMMENDED TOOLS: ROTARY 2

100% twisted wool is the most aggressive they come, and is found in almost any shop or arsenal of products. Used in every industry, these wool pads are a standard for heavy cutting applications. Choose a shorter pile to increase aggression when compounding or longer pile to increase durability.

100% Twisted Wool	Description	Thickness	8" Fits 7" Backing Plate	7-1/2" Fits 7" Backing Plate	6-1/2" Fits 6" Backing Plate	3" Fits 3" Backing Plate	2" Fits 2" Backing Plate
	Curved Edge 100% Unsteamed Twisted Wool Pad	1"		41-015 (Hook & loop) 11-111 (Bolt-on)	41-005 (Hook & loop)	41-003C (Hook & loop)	
		1-1/4"		41-025 (Hook & loop) 11-211 (Bolt-on)			
		1-1/2"		41-125 (Hook & loop) 11-311 (Bolt-on)	41-125A (Hook & loop)		
		2"		41-225 (Hook & loop) 21-411 (Bolt-on)			
	Curved Edge 100% Steamed Twisted Wool Pad	1"	10-020 (Hook & loop) 10-021 (Bolt-on)	10-010 (Hook & loop)		21-231 (Roloc)	21-120 (Hook & loop) 21-221 (Roloc)
		1-1/4"	10-060 (Hook & loop) 10-061 (Bolt-on)	10-050 (Hook & loop)		21-130 (Hook & loop)	
		1-1/2"	10-100 (Hook & loop) 10-111 (Bolt-on)	10-040 (Hook & loop) 10-041 (Bolt-on)			

PROFILE

Attachment method:

Hook & loop

Backing plate: 43-160WH

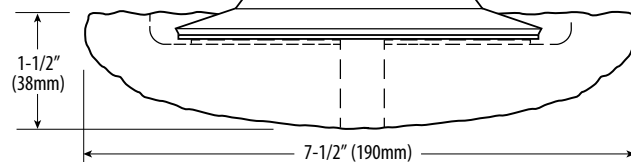

Backing plate: 43-175M

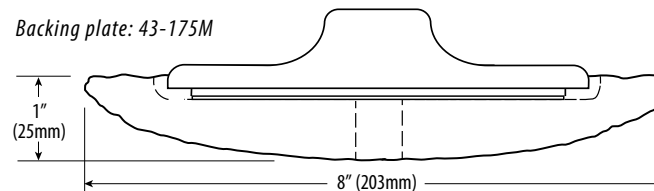

CURVED

50/50 BLEND

RECOMMENDED TOOLS: ROTARY 2

50/50 Steamed Twisted Wool/Polyester	Description	Thickness	8" Fits 7" Backing Plate	7-1/2" Fits 7" Backing Plate
	50/50 Steamed Twisted Wool/Polyester Pad	1-1/2"	19-900 (Hook & loop)	19-041 (Bolt-on) 19-040 (Hook & loop)
	50/50 Steamed Twisted/Untwisted 100% Wool		14-400 (Hook & loop) 14-411 (Bolt-on)	

PROFILE

Attachment method: Hook & loop or bolt-on

Backing plate: 43-175M
for hook & loop

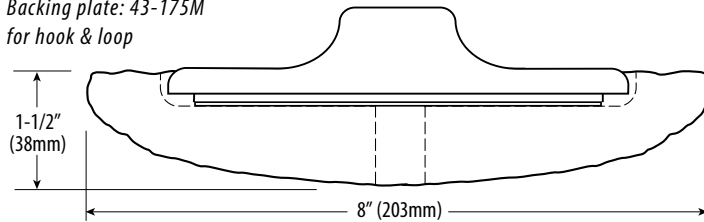

50/50 Unsteamed Wool/Acrylic Blend	Description	Thickness	7-1/2" Fits 7" Backing Plate	6-1/2" Fits 6" Backing Plate
	50% Twisted 4-Ply Wool 50% Untwisted Acrylic	1-1/2"	41-425 (Hook & loop) 31-611 (Bolt-on)	41-425A (Hook & loop)

PROFILE

Attachment method: Hook & loop or bolt-on

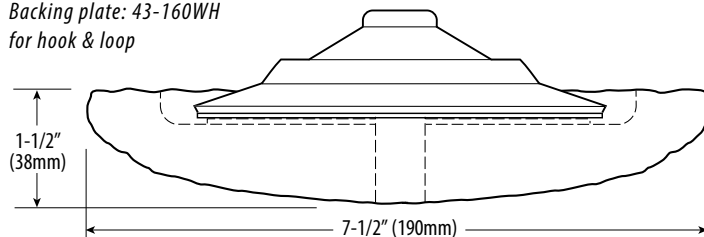

Backing plate: 43-160WH
for hook & loop



CURVED WOOL/ACRYLIC

RECOMMENDED TOOLS: ROTARY 2

The wool acrylic blend softens the feel and increases the glossing or finishing ability. These pads have a number of uses and perform well on gelcoats and harder paint finishes.

Twisted Wool/Acrylic	Description	Thickness	8" Fits 7" Backing Plate	7-1/2" Fits 7" Backing Plate	6-1/2" Fits 6" Backing Plate
	40/60 Unsteamed Twisted Wool/Acrylic Pad	1"			41-345A (Hook & loop)
		1-1/2"		41-355A (Hook & loop) 31-811A (Bolt-on)	
	40/60 Steamed Twisted Wool/Acrylic Pad	1-1/2"	12-200 (Hook & loop) 12-211 (Bolt-on)		
		1"			41-305 (Hook & loop)
	60/40 Unsteamed Untwisted Wool/ Acrylic Pad	1-1/2"		41-325D (Hook & loop)	
		1-1/2"	18-800 (Hook & loop) 18-811 (Bolt-on)		

PROFILE

Attachment method: Hook & loop or bolt-on

Backing plate 43-160WH
for hook & loop

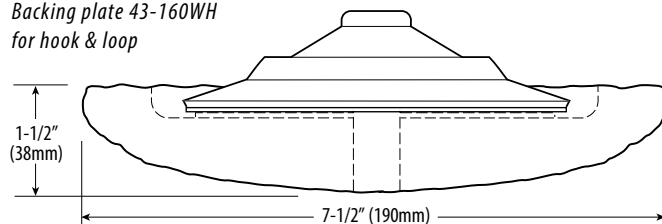

100% UNTWISTED WOOL

RECOMMENDED TOOLS: ROTARY 2

Untwisted strands increase finishing ability similar to the acrylic blended pad. Untwisted strands create a fluffy or fuzzy feel and keeps the strand vertical more than a twisted strand. This helps retain the cutting ability of 100% wool, but still increase finishing ability.

100% Untwisted Steamed Wool	Description	Thickness	8" Fits 7" Backing Plate
	100% Steamed Untwisted Wool Pad	1-1/2"	15-500 (Hook & loop) 15-511 (Bolt-on)

PROFILE

Attachment method: Hook & loop or bolt-on

Backing plate 43-175M
for hook & loop

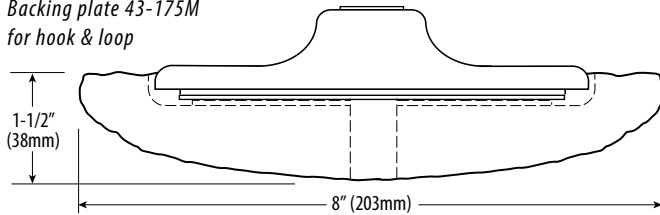

100% UNTWISTED WOOL/SILK

RECOMMENDED TOOLS: ROTARY 2

The untwisted silk wool blend is the softest and finest wool polishing pad available, and offers an unmatched finish due to the extremely soft untwisted tufts. Unlike other pads, silk wool blended pads stand alone in our industry, further adding to the variety of exclusive pads offered in our line.

100% Steamed Untwisted Wool/Silk	Description	Thickness	8" Fits 7" Backing Plate
	100% Steamed Untwisted Wool/Silk Pad	1-1/2"	16-600 (Hook & loop)

PROFILE

Attachment method: Hook & loop or bolt-on

Backing plate 43-175M
for hook & loop

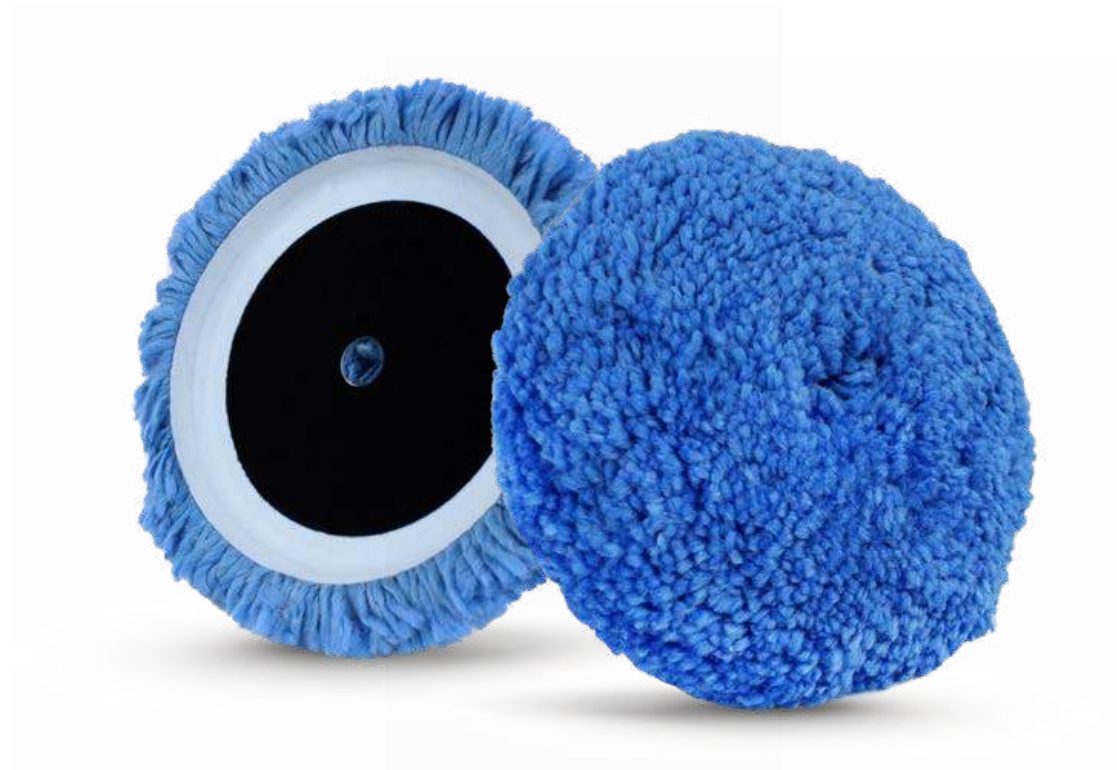
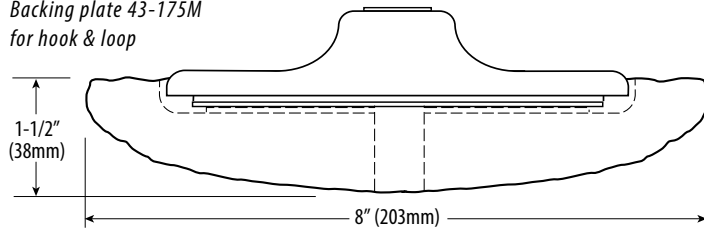

DOUBLE SIDED WOOL

RECOMMENDED TOOLS: ROTARY 2

Double sided wool pads have become a standard in the composite, body shop, and industrial markets. Centered every time and always balanced to save time and reduce fatigue.

Description	Thickness	8"	6"
		Adapter 5/8"-11 Thread PN-46-229	
Yellow <i>Steamed</i> Untwisted Wool/ Acrylic Pad	1-1/2"	18-822	
Yellow <i>Steamed</i> Twisted Wool/ Acrylic Pad	1"		35-550
	1-1/2"	35-555A	
White <i>Steamed</i> Twisted 100% Wool Pad	1"	35-221	35-220
	1-1/4"	10-062	
	1-1/2"	35-222	
50% Twisted 4-Ply Wool 50% Untwisted Acrylic	1-1/2"	14-422	
White <i>Steamed</i> Untwisted 100% Wool Pad	1-1/2"	15-522	15-520

PROFILE

Attachment method:
Bolt-on adapter 46-229 or
46-229-14MM

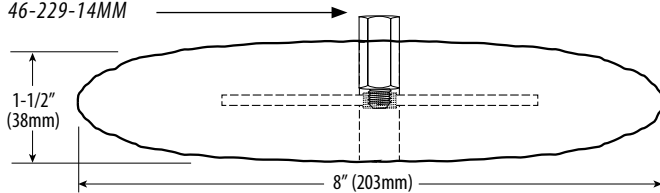

AGGRESSION

LAKE COUNTRY MASTER CHART

Rotate
page
clockwise

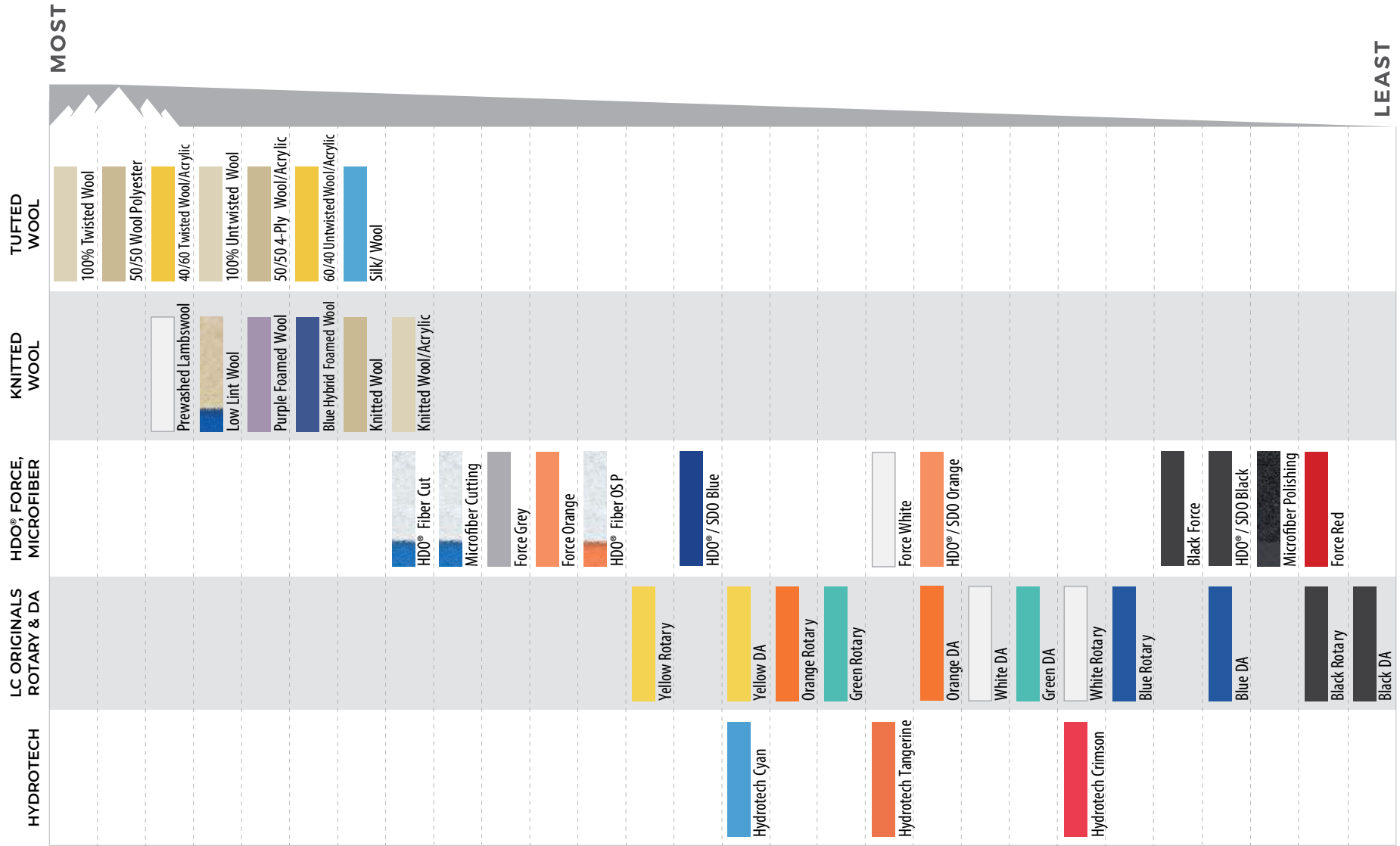



PERFECTLY BALANCED

Perfectly molded urethane for a smooth, balanced experience.



UNIVERSAL

Options of 14mm and 5/8" threads, we have a plate to fit any need or pad size.



DURABILITY

High quality, molded urethane create a durable, long lasting plate.

ATTACHMENT METHODS

BACKING PLATES

BACKGROUND

Extra soft polyurethane plates conform to panels, creating a smooth, unmatched performance and feel. The unique polyurethane density allows the user to adjust pressure to fit their technique.

Premium molded, high strength backing plates offer a full range of sizes and shapes for tools and various uses. Highly flexible and agile, these plates create a different feel than an extra soft polyurethane plate.

While our molded urethane are more rigid and dense material, they offer a very flexible option when polishing in concaved or very curved panels. The plate offers a balance of structure and flexibility, offering increased performance in all industries including composites.



BACKING PLATES

ATTACHMENT METHODS

WHITE EXTRA SOFT EDGE ROTARY BACKING PLATES

The white ultra-dense urethane not only can easily glide over all surfaces but is extremely durable as well.

RECOMMENDED TOOLS: ROTARY 2

White Extra Soft Edge Rotary	Thread Size	6"	5"	3"	2"
		Dimensions 150mm (6")	Dimensions 125mm (4-3/4")	Dimensions 73mm (2-7/8")	Dimensions 50mm (2-7/8")
	5/8" x 11	45-936	45-929	45-175	45-150



YELLOW URETHANE ROTARY BACKING PLATES

High strength molded urethane helps absorb the heat created while also allowing flexibility over the buffing surface.

Yellow Urethane Rotary	Thread Size	7"	6-1/4"	6"	5"	4"	3"
		Dimensions 175mm (6-7/8")	Dimensions 160mm (6-1/4")	Dimensions 150mm (6")	Dimensions 125mm (4-3/4")	Dimensions 95mm (3-3/4")	Dimensions 73mm (2-7/8")
	14mm		43-160WH-14MM	M43-150-14MM	43-125WH-14MM		43-073-14MM
	5/8" x 11	43-175M or 43-175	43-160WH	43-150	43-125WH	43-095	43-073M
	16mm		43-160WH-16MM	43-150-16MM			



YELLOW URETHANE DA BACKING PLATES

RECOMMENDED TOOLS: DA 1

Yellow Urethane DA	Thread Size	6"	5"	3-1/2"	3"
		Dimensions 148mm (5-7/8")	Dimensions 125mm (4-7/8")	Dimensions 85mm (3-1/2")	Dimensions 73mm (2-7/8")
	5/16" x 24	43-148DAR	43-125DAR	43-085DA	43-073DA

BACKING PLATE ADAPTERS

Easily modify your rotary backing plate to be used on a Dual Action polisher or a drill with Lake Country adapters. Each adapter includes a washer.

Description	Part Number
5/8-11 Rotary to DA Adapter	46-230
5/8-11 Rotary to Drill Adapter	46-231

ACCESSORIES



ROTARY EXTENSIONS

Reach in tight and difficult areas with Lake Country's rotary extensions. Made of precisely machined high quality stainless steel, these extensions are developed to perform without wobble, skipping, or hopping.

Each kit contains a 6" and 3" extension, combine to make 9" of total extension.

Description	Part Number
Extension Kit	EXT-KIT



SCUFF BALLS™

Durable, non-woven abrasive material, Scuff Balls™ replaces labor intensive scuffing for multiple applications in a variety of industries.

Description	4"	2-1/2"
White Ultra Fine Scuff Ball (1200 Grit)	80-6400	80-6250
Grey Light Duty Scuff Ball (900 Grit)		80-7250
Green General Purpose Scuff Ball (320 Grit)	80-3400	80-3250
Maroon Industrial Scuff Ball (180 Grit)	80-8400	80-8250
Black Heavy Duty Scuff Ball (100 Grit)	80-7400 BLK	80-7250 BLK



PRECISION APPLICATORS

With a versatile shape, precision applicators are designed to access a variety of tight spaces with a comfortable, easy to grip handle.

Description	3.75"
Yellow Precision Scrubber w/ Handle	89-200 SCRUB YL
Black Precision Dressing Applicator w/ Handle	89-200 DRESS BK
Red Precision Applicator w/ Handle	89-200 APP RD



MICROFIBER TOWELS

Korean microfiber towels that are great for both drying and removing residue. Available in 4/bag or 50/bag. Combo blue & gold is only available as 4/bag.

Description	16 x 16"
Microfiber Detailing Cloth (2 Blue & 2 Gold)	87-210
Microfiber Detailing Cloth (Blue)	87-210BBL
Microfiber Detailing Cloth (Gold)	87-210G01
Microfiber Detailing Cloth (Navy Blue) Edgeless	87-210BNB



WOOL BALLS

Industrial grade, 100% twisted wool ball is great for contour buffing in automotive, marine and aviation industries.

Description	4.5"	3"
Wool Ball <i>Includes Hex Shaft Adapter</i>	81-145	81-103



WASH WEDGE

Grid design channels dirt particles into grooves and away from painted surface which minimizes any marring.

Description	4 x 6-1/4 x 7-1/4"
Gold/Black Wash Wedge	99-WASH WEDGE



ULTI-MITT

The ultimate wash mitt on the market today! The radius grid design channels dirt particles into grooves and away from painted surface.

Description	11 x 13"
Red/Charcoal Foam Wash Mitt	ULTI MITT RC
Yellow/Charcoal Foam Scrub Mitt	ULTI MITT YC

PAD WASHERS

Patented buffer powered pad washers effectively clean and condition both foam and wool pads, in less than 30 seconds, for better performance and extend the life of your LC pads.

Description	Part Number
System 2000 Pad Washer	90-2000P
System 3000™ Pad Washer	90-3000
System 3000™ Deluxe Model Pad Washer w/ Filtration	90-3000D

PAD WASHER ACCESSORIES

Accessories include the original Snappy Clean Boost™ Pad Cleaning Powder, a concentrated cleaner that releases wax and polish from the foam or wool pads with just a few minutes of soaking. Biodegradable, non-flammable, and rinses out easily.

Description	Part Number
Pad Cleaning Spur	89-104
Aqua-Clean Filters (package of 2)	90-3000 AC
Snappy Clean Boost (Citrus 1.25 oz. packet)	92-003
System 2000 Overhaul Kit	97-200

APPLICATOR PADS

Foam wax applicators are possibly the most widely used detailing tool ever.

Description	4.5"
CCS Foam Applicator w/ Sealed Edges (Red)	78-14X4.5 RD
CCS Foam Applicator w/ Sealed Edges (Gold)	78-44X4.5 GO



System 3000™

The System 3000™ with Aqua-Clean Technology is a self-contained cleaning system featuring a user controlled pump, a removable catch basin and a replaceable filter.

Easy and effective to use for all types of pads and most polishers. This water-saving unit is perfect for applications where cleaner pads with less contamination are essential.

CARE INSTRUCTIONS

PAD CLEANING SOLUTION

Lake Country offers a proprietary pad cleaning solution called Snappy Clean Boost, that can easily clean pads anywhere you go. Snappy Clean Boost is conveniently packaged in a 1.25 oz. package that you can mix on the go, and is safe for use on wool, foam, microfiber and knitted pads. Snappy Clean Boost is an emulsified mixture, making it easy to rinse from the pad after cleaning is complete.

KNITTED WOOL PADS

Knitted wool pads can be easily cleaned with a standard pad brush or can be washed using the System 2000 or 3000™ pad washer. These pads can also be washed in a washing machine, but wool pads can become slightly altered when washed or cleaned with water.

Pad brush

Option 1: System 2000 or 3000™ pad washer

- Wash with Snappy Clean Boost solution mix in washer
- Rinse with clean water
- Air dry

Option 2: Machine Wash

- Remove all dried residue with spur prior to washing
- Snappy Clean Boost pad cleaner
- Gentle cycle
- Cold water only; warm or hot water can cause issues with wool shrinkage etc.
- Allow to air dry

MICROFIBER PADS

Microfiber pads should be cleaned regularly to remove built up polish and residue in the pad and fluff the microfiber material for better performance. Because these pads are manufactured using different materials, they can be cleaned with compressed air, unlike other types of pads.

Compressed air

- Blow gun or tornado
- Must use respirator or dust mask and eye protection

Pad brush

Option 1: System 3000™ pad washer

- Wash with Snappy Clean Boost solution mix in pad washer
- Rinse with clean water
- Allow to air dry

Option 2: Machine Wash

- LC recommends washing less than 10 pads at a time, then removing them from the washing machine promptly after cycle is complete. Pads can be damaged or permanently deformed if left in the washing machine after spin cycle is complete. Same will occur if too many pads are washed at once as well.
- Snappy Clean Boost pad cleaner
- Gentle cycle
- Cold and warm water only. Hot water can shrink velcro loop.
- Allow to air dry



TIPS FOR LONGEVITY

- Always dry pad 100% completely before storing in bin or bag. If moisture remains, mold can form and deteriorate the foam pad.
- When switching pads during the polishing process, toss the soiled pad in a bucket with some water to help soften the built up residue and compound to avoid it from drying in the pad. When the job is complete, the pads usually will clean much easier if they haven't been left to dry.

TUFTED WOOL PADS

LC recommends these pads be cleaned regularly using a metal spur made for this specific application. The spur helps break up compound and residue that has built up and dried in the pad. Wool pads can be cleaned with water, but at your own discretion. These pads are built to withstand the washing process, but wool can shrink and modify during the cleaning process once water is introduced. Washing with water will not “damage” the pad but can change the buffing performance. If washed with water, we recommend using Snappy Clean Boost pad cleaning powder to break up and clean residue, then fully rinsing pad clean

Spur clean dry pad

- Reduce polisher speed to avoid injury and use spur to break up and clean compound residue from pad. Eye protection required.

Option 1: System 2000 pad washer

Option 2: Machine Wash

- Remove all dried residue with spur prior to washing
- Snappy Clean Boost pad cleaner
- Gentle cycle
- Cold water only; warm or hot water can cause issues with wool shrinkage etc.
- Allow to air dry

FOAM PADS

Foam pads can be cleaned a number of ways, and if properly cleaned, it can lengthen the overall pad life. NOTE – using a pressure washer, or high pressure compressed air can damage, or reduce the longevity of the foam or foam pad. We recommend using a different method to avoid any issues.

Pad brush

Option 1: System 2000 or 3000™ pad washer

- Wash with Snappy Clean boost solution mix in washer
- Rinse with clean water
- Air dry

Option 2: Machine Wash

- LC recommends washing less than 10 pads at a time maximum and removing them from the washing machine promptly after cycle is complete. Pads can be damaged or permanently deformed if left in the washing machine after spin cycle is complete. Same will occur if too many pads are washed at once as well.
- Snappy Clean Boost pad cleaner
- Gentle cycle
- Cold and warm water only. Hot water can shrink velcro loop.
- Allow to air dry



LAKE COUNTRY MANUFACTURING, INC

950 BLUE RIBBON CIR N, OCONOMOWOC, WI 53066 USA

WWW.LAKECOUNTRYMFG.COM | CONTACT PHONE: (262) 367-8395